

Air conditioner

Installation manual

AC***BXAP*G

- Thank you for purchasing this Samsung air conditioner.
- Before operating this unit, please read this manual carefully and retain it for future reference.



SAMSUNG

Contents

Safety Information	4
Installing the unit	5
Power supply line, fuse or circuit breaker	6
Installation Procedure	7
Step 1 Choosing the installation location	7
Step 2 Checking and preparing accessories and tools	10
Step 3 Fixing the outdoor unit in place	10
Step 4 Connecting the power cables, communication cable, and controllers	11
Step 5 Optional: Extending the power cable	17
Step 6 Connecting the refrigerant pipe	19
Step 7 Optional: Cutting and flaring the pipes	20
Step 8 Installing oil traps	21
Step 9 Connecting up and removing air in the circuit	22
Step 10 Adding refrigerant (R-32)	23
Step 11 Performing the gas leak test	26
Step 12 Draining the water naturally	27
Step 13 Insulating the refrigerant pipes	27
Step 14 Checking the earthing	28
Step 15 Performing final check and trial operation	29
Extra procedures	32
Pumping down refrigerant	32
Relocating the indoor and outdoor units	32
Using the stop valve	33
Maintenance Procedures	34
Performing the gas leak tests for repair	34
Decommissioning	34
Appendix	35
Troubleshooting	35
Technical specifications	37



***Correct Disposal of This Product
(Waste Electrical & Electronic Equipment)***

(Applicable in countries with separate collection systems)

This marking on the product, accessories or literature indicates that the product and its electronic accessories (e.g. charger, headset, USB cable) should not be disposed of with other household waste at the end of their working life. To prevent possible harm to the environment or human health from uncontrolled waste disposal, please separate these items from other types of waste and recycle them responsibly to promote the sustainable reuse of material resources.

Household users should contact either the retailer where they purchased this product, or their local government office, for details of where and how they can take these items for environmentally safe recycling.

Business users should contact their supplier and check the terms and conditions of the purchase contract. This product and its electronic accessories should not be mixed with other commercial wastes for disposal.

For information on Samsung's environmental commitments and product regulatory obligations, e.g. REACH, visit our sustainability page available via www.samsung.com

Safety Information

WARNING

- Hazards or unsafe practices that may result in severe personal injury or death.

CAUTION

- Hazards or unsafe practices that may result in minor personal injury or property damage.
- Carefully follow the precautions listed below because they are essential to guarantee the safety of the equipment.

WARNING

- Always disconnect the air conditioner from the power supply before servicing it or accessing its internal components.
- Verify that installation and testing operations are performed by qualified personnel.
- Verify that the air conditioner is not installed in an easily accessible area.

General information

WARNING

- Carefully read the content of this manual before installing the air conditioner and store the manual in a safe place in order to be able to use it as reference after installation.
- For maximum safety, installers should always carefully read the following warnings.
- Store the operation and installation manual in a safe location and remember to hand it over to the new owner if the air conditioner is sold or transferred.
- This manual explains how to install an indoor unit with a split system with two SAMSUNG units. The use of other types of units with different control systems may damage the units and invalidate the warranty. The manufacturer shall not be responsible for damages arising from the use of non compliant units.
- The manufacturer shall not be responsible for damage originating from unauthorized changes or the improper connection of electric and requirements set forth in the "Operating limits" table, included in the manual, shall immediately invalidate the warranty.
- The air conditioner should be used only for the applications for which it has been designed: the indoor unit is not suitable to be installed in areas used for laundry.
- Do not use the units if damaged. If problems occur, switch the unit off and disconnect it from the power supply.
- In order to prevent electric shocks, fires or injuries, always stop the unit, disable the protection switch and contact SAMSUNG's technical support if the unit produces smoke, if the power cable is hot or damaged or if the unit is very noisy.
- Always remember to inspect the unit, electric connections, refrigerant tubes and protections regularly. These operations should be performed by qualified personnel only.
- The unit contains moving parts, which should always be kept out of the reach of children.
- Do not attempt to repair, move, alter or reinstall the unit. If performed by unauthorized personnel, these operations may cause electric shocks or fires.
- Do not place containers with liquids or other objects on the unit.
- All the materials used for the manufacture and packaging of the air conditioner are recyclable.
- The packing material and exhaust batteries of the remote controller(optional) must be disposed of in accordance with current laws.
- The air conditioner contains a refrigerant that has to be disposed of as special waste. At the end of its life cycle, the air conditioner must be disposed of in authorized centres or returned to the retailer so that it can be disposed of correctly and safely.
- Wear protective equipment (such as safety gloves, goggles, and headgear) during installation and maintenance works. Installation/repair technicians may be injured if protective equipment is not properly equipped.
- Do not use means to accelerate the defrost operation or to clean, other than those recommended by Samsung.
- Do not pierce or burn.
- Be aware that refrigerants may not contain an odour.
- This appliance is not intended for use by persons (including children) with reduced physical, sensory or mental capabilities, or lack of experience and knowledge, unless they have been given supervision or instruction concerning use of the appliance by a person responsible for their safety. Children should be supervised to ensure that they do not play with the appliance.

- For use in Europe: This appliance can be used by children aged from 8 years and above and persons with reduced physical, sensory or mental capabilities or lack of experience and knowledge if they have been given supervision or instruction concerning use of the appliance in a safe way and understand the hazards involved. Children shall not play with the appliance. Cleaning and user maintenance shall not be made by children without supervision.

Installing the unit



WARNING

IMPORTANT: When installing the unit, always remember to connect first the refrigerant tubes, then the electrical lines.

- Upon receipt, inspect the product to verify that it has not been damaged during transport. If the product appears damaged, DO NOT INSTALL it and immediately report the damage to the carrier or retailer (if the installer or the authorized technician has collected the material from the retailer.)
- After completing the installation, always carry out a functional test and provide the instructions on how to operate the air conditioner to the user.
- Do not use the air conditioner in environments with hazardous substances or close to equipment that release free flames to avoid the occurrence of fires, explosions or injuries.
- Do not install the product in a place where thermohygrostat is needed (such as server room, machinery room, computer room, etc.) Those places do not provide guaranteed operation condition of the product therefore performance can be poor in these places.
- Do not install the product in a ship or a vehicle (such as a campervan). Salt, vibration or other environmental factor may cause the product malfunction, electric shock or fire.
- Our units should be installed in compliance with the spaces shown in the installation manual, to ensure accessibility from both sides and allow repairs or maintenance operations to be carried out. The unit's components should be accessible and easy to disassemble without endangering people and objects.
- For this reason, when provisions of the installation manual are not complied with, the cost required to access and repair the units (in SAFETY CONDITIONS, as set out in prevailing regulations) with harnesses, ladders, scaffolding or any other elevation system will NOT be considered part of the warranty and will be charged to the end customer.
- The outdoor unit shall be installed in an open space that is always ventilated.
- The local gas regulations shall be observed.
- To handle, purge, and dispose the refrigerant, or break into the refrigerant circuit, the worker should have a certificate from an industry-accredited authority.
- While in installation or relocation of the product, do not mix the refrigerant with other gases including air or unspecified refrigerant. Failure to do so may cause pressure increase to result in rupture or injury.
- Do not cut or burn the refrigerant container or pipings.
- Use clean parts such as manifold gauge, vacuum pump, and charging hose for the refrigerant.
- Installation must be carried out by qualified personnel for handling the refrigerant. Additionally, reference the regulations and laws.
- Be careful not to let foreign substances (lubricating oil, refrigerant, water, etc.) enter the pipings.
- When mechanical ventilation is required, ventilation openings shall be kept clear of obstruction.
- For disposal of the product, follow the local laws and regulations.
- Do not work in a confined place.
- The work area shall be blocked.
- The refrigerant pipings shall be installed in the position where there are no substances that may result in corrosion.
- The following checks shall be performed for installation:
 - The charging amount depends on the room size.
 - The ventilation devices and outlets are operating normally and are not obstructed.
 - Markings and signs on the equipment shall be visible and legible.
- Upon leakage of the refrigerant, ventilate the room. When the leaked refrigerant is exposed to flame, it may cause generation of toxic gases.

Safety Information

- Make sure that the work area is safe from flammable substances.
- To purge air in the refrigerant, be sure to use a vacuum pump which is compatible with R-32.
- Note that the refrigerant has no odour.
- The units are not explosion proof so they must be installed with no risk of explosion.
- This product contains fluorinated gases that contribute to global greenhouse effect. Accordingly, do not vent gases into the atmosphere.
- For installation with handling the refrigerant(R-32), use dedicated tools and piping materials. Working pressure of R-32 is higher than R410A, So failure to use the dedicated tools and piping materials may cause rupture or injury. Furthermore, it may cause serious accidents such as water leakage, electric shock or fire.
- Servicing shall be performed as recommended by the manufacturer. In case other skilled persons are joined for servicing, it shall be carried out under supervision of the person who is competent in handling flammable refrigerants.
- For servicing the units containing flammable refrigerants, safety checks are required to minimise the risk of ignition. R-32 is slightly more flammable than R410A hence additional precautions are required when dealing with it.
- Servicing shall be performed following the controlled procedure to minimize the risk of flammable refrigerant or gases.
- Do not install where there is a risk of combustible gas leakage.
- Do not place heat sources.
- Be cautious not to generate a spark as follows:
 - Do not remove the fuses with power on.
 - Do not disconnect the power plug from the wall outlet with power on.
 - It is recommended to locate the outlet in a high position. Place the cords so that they are not tangled.
- If the indoor unit is not R-32 compatible, an error signal appears and the unit will not operate.
- After installation, check for leakage. Toxic gas may be generated and if it comes into contact with an ignition source such as fan heater, stove, and cooker, cylinders, make sure that only the refrigerant recovery cylinders are used.

- Never directly touch any accidental leaking refrigerant. It could result in severe wounds caused by frostbite.

Power supply line, fuse or circuit breaker

WARNING

- Always make sure that the power supply is compliant with current safety standards. Always install the air conditioner in compliance with current local safety standards.
- Always verify that a suitable earthing connection is available.
- Verify that the voltage and frequency of the power supply comply with the specifications and that the installed power is sufficient to ensure the operation of any other domestic appliance connected to the same electric lines.
- Always verify that the cut-off and protection switches are suitably dimensioned.
- Verify that the air conditioner is connected to the power supply in accordance with the instructions provided in the wiring diagram included in the manual.
- Always verify that electric connections (cable entry, section of leads, protections...) are compliant with the electric specifications and with the instructions provided in the wiring scheme. Always verify that all connections comply with the standards applicable to the installation of air conditioners.
- Devices disconnected from the power supply should be completely disconnected in the condition of overvoltage category.
- Be sure not to perform power cable modification, extension wiring, and multiple wire connection.
 - It may cause electric shock or fire due to poor connection, poor insulation, or current limit override.
 - When extension wiring is required due to power line damage, refer to **Step 5 Optional: Extending the power cable** in the installation manual.

Installation Procedure

Step 1 Choosing the installation location



WARNING

- Because your air conditioner contains R-32 refrigerant, make sure that it is installed, operated, and stored in a room whose floor area is larger than the minimum required floor area specified in the following table:

Minimum required room area (A, m ²)			
m (kg)	Ceiling-mounted type	Wall-mounted type	Floor-standing type
≤1.842	No requirement		
1.843	3.64	4.45	28.9
1.9	3.75	4.58	30.7
2.0	3.95	4.83	34.0
2.2	4.34	5.31	41.2
2.4	4.74	5.79	49.0
2.6	5.13	6.39	57.5
2.8	5.53	7.41	66.7
3.0	5.92	8.51	76.6
3.2	6.48	9.68	87.2
3.4	7.32	10.9	98.4
3.6	8.20	12.3	110
3.8	9.14	13.7	123
4.0	10.1	15.1	136
4.2	11.2	16.7	150
4.4	12.3	18.3	165
4.6	13.4	20.0	180
4.8	14.6	21.8	196
5.0	15.8	23.6	213
5.2	17.1	25.6	230
5.4	18.6	27.6	248
5.6	20.0	29.7	267
5.8	21.5	31.8	286
6.0	23.0	34.0	306

- m : Total refrigerant charge in the system
- A : Minimum required room area
- **IMPORTANT:** it's mandatory to consider either the table 1 or taking into consideration the local law regarding the minimum living space of the premises.
- Minimum installation height of indoor unit is 0.6 m for floor mounted, 1.8 m for wall, 2.2 m for ceiling.

Installation location requirements

- Do not place the outdoor unit on its side or upside down. Failing to do so may cause the compressor lubrication oil to run into the cooling circuit and lead to a serious damage to the unit.
- Install the unit in a well-ventilated location away from direct sunlight or strong winds.
- Install the unit in a location that would not obstruct any passageways or thoroughfares.
- Install the unit in a location that would not inconvenience or disturb your neighbors, as they could be affected by the noise or the airflow coming from the unit.
- Install the unit in a location where the pipes and the cables can be easily connected to the indoor unit.
- Install the unit on a flat, stable surface that can withstand the weight of the unit. Otherwise, the unit can generate noise and vibration during operation.
- Install the unit so that the air flow is directed towards the open area.
- Maintain sufficient clearance around the outdoor unit, especially from a radio, computer, stereo system, etc.

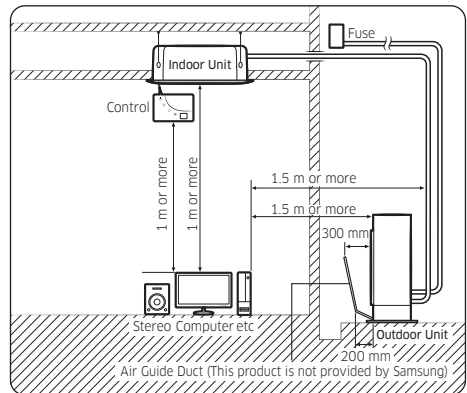

- Install the unit at a height where its base can be firmly fixed in place.
- Make sure that the water dripping from the drain hose runs away correctly and safely.

Installation Procedure

⚠ CAUTION

- This device must be installed according to the national electrical rules.
- If your outdoor unit exceeds a net weight of 60 kg, do not install it on a suspended wall, but stand it on a floor.
- When installing the outdoor unit at the seaside, an additional protective coating (third party) may be required. Make sure that it is not directly exposed to sea breeze. If you cannot find an adequate place free from direct sea breeze, construct a protection wall or a protective fence.
 - Install the outdoor unit in a place (such as near buildings etc.) where it can be prevented from sea breeze. Failure to do so may cause a damage to the outdoor unit.

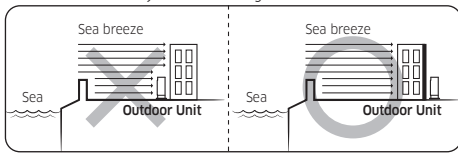

- If you cannot avoid installing the outdoor unit at the seaside, construct a protection wall around to block the sea breeze.
- Construct a protection wall with a solid material such as concrete to block the sea breeze. Make sure that the height and the width of the wall are 1.5 times larger than the size of the outdoor unit. Also, secure a space larger than 700 mm between the protection wall and the outdoor unit for exhausted air to ventilate.

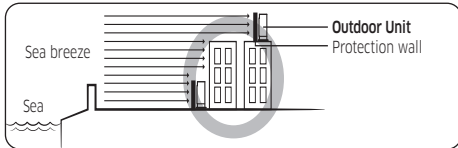

⚠ CAUTION

- In areas with heavy snow fall, piled snow could block the air intake. To avoid this incident, install a frame that is higher than estimated snow fall. In addition, install a snow-proof hood to avoid snow from piling on the outdoor unit.

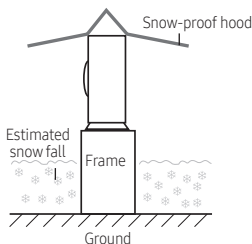

⚠ CAUTION

- Depending on the condition of power supply, unstable power or voltage may cause malfunction of the parts or control system. (At the ship or places using power supply from electric generator...etc)
- Install the unit in a place where water can drain smoothly.
- If you have any difficulty finding installation location as prescribed above, contact your manufacturer for details.
- Be sure to clean the heat exchanger and base plate of the outdoor unit regularly from any collected sand and salt. Touch up the additional protective coating (third party) if needed, at least once in a year or according to the third party's product requirements.
- Check the condition of the product periodically.
 - Check the installation site every 3 months and perform anti-corrosion treatment such as R-Pro supplied by SAMSUNG (Code: MOK-220SA) or commercial water repellent grease and wax, etc., based on the product condition.
 - When the product is to be shut down for a long period of time, such as off-peak hours, take appropriate measures like covering the product.
- If the product installed within 500m of seashore, special anti-corrosion treatment is required.
 - * Please contact your local SAMSUNG representative for further details.

Outdoor unit dimensions

(Unit: mm)

A Type	
AC071BXAPKG/AC071BXAPNG	
B Type	
AC100BXAPKG/AC100BXAPNG/AC120BXAPNG/AC140BXAPNG	

Minimum clearances for the outdoor unit

When installing 1 outdoor unit

(Unit: mm)

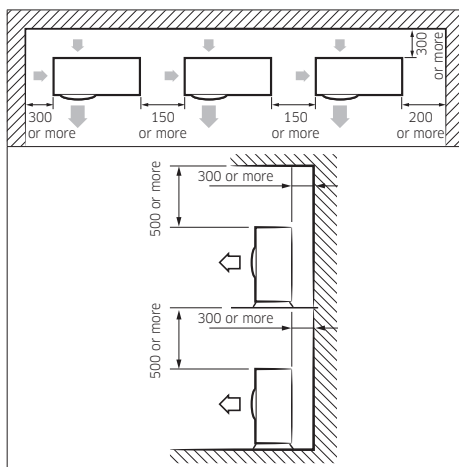
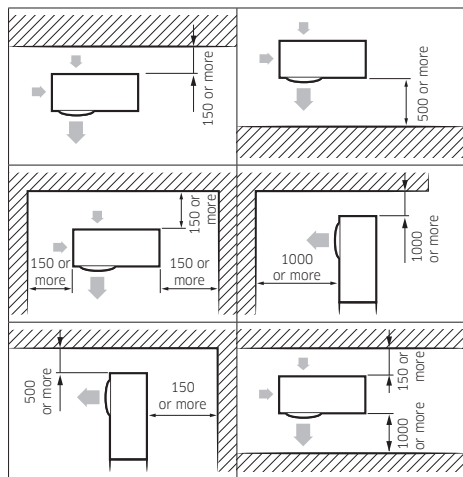

When installing more than 1 outdoor unit

(Unit: mm)

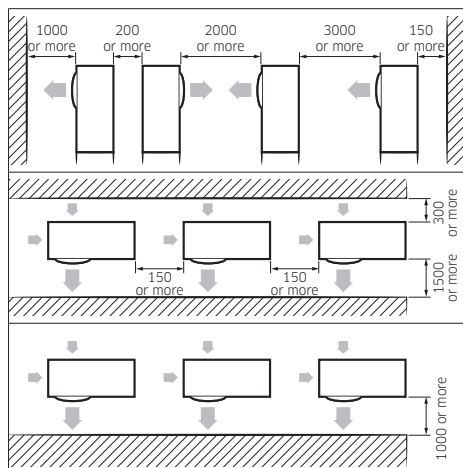

⚠ CAUTION

- The outdoor unit must be installed according to the specified distances in order to permit accessibility from each side, to guarantee correct operation, maintenance, and repair of the unit.

The components of the outdoor unit must be reachable and removable under safe conditions for people and the unit.

⚠ WARNING

- Should adopt bar type louver. Don't use a type of rain resistance louver.

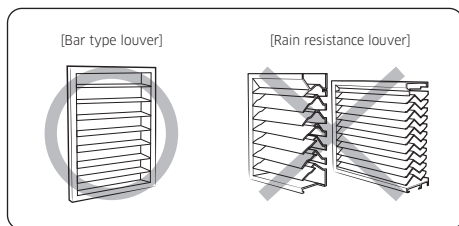

- Louver specifications.
 - Angle criteria : less than 20°
 - Opening ratio criteria : greater than 80%

Installation Procedure

Moving the outdoor unit with wire rope

- 1 Before carrying the outdoor unit, fasten two wire ropes of 8 m or longer, as shown in the figure.
- 2 To prevent damages or scratches effectively, insert a piece of cloth between the outdoor unit and the ropes.
- 3 Move the outdoor unit.

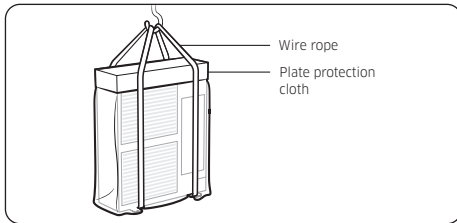

Step 2 Checking and preparing accessories and tools

Energy Label	Rubber Leg
Installation Manual	

NOTE

- Wire assembly cables are optional. If they are not supplied, use standard cables.
- The rubber legs are included only when the air conditioner is supplied without assembly pipes.
- If these accessories are supplied, they are in the accessory package or outdoor unit package.

Step 3 Fixing the outdoor unit in place

Install the outdoor unit on a rigid and stable base to prevent disturbance from any noise caused by vibration. When installing the unit at a height or in a location exposed to strong winds, fix the unit securely to a support (i.e., a wall or a ground).

Fix the outdoor unit with anchor bolts. Make sure that the anchor bolts are 20 mm or higher from the base surface.

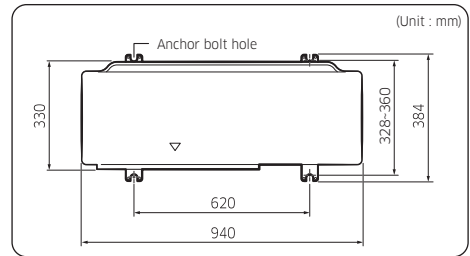

CAUTION

- When installing the outdoor unit on the roof, waterproof the unit and check the ceiling strength.

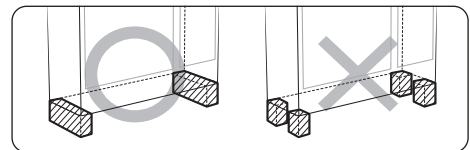

- Make sure that the wall can support the weights of the rack and the outdoor unit.
- Install the rack close to the column as much as possible.
- Make sure that the rack is not placed under the drain hole.

Optional: Fixing the outdoor unit to a wall with a rack

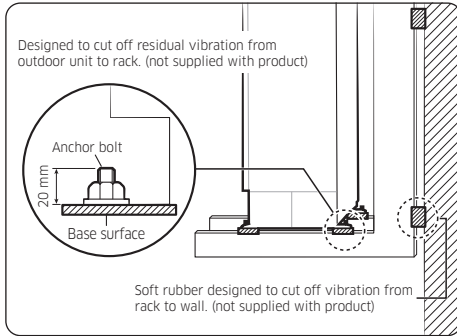

- Install a proper grommet in order to reduce noise and residual vibration transferred by the outdoor unit towards the wall.

CAUTION

- When installing an air guide duct, be sure to check the following:
 - The screws do not damage the copper pipe.
 - The air guide duct is fixed firmly on the guard fan.

Step 4 Connecting the power cables, communication cable, and controllers

You must connect the following three electrical cables to the outdoor unit:

- The main power cable between the auxiliary circuit breaker and the outdoor unit.
- The outdoor-to-indoor power cable between the outdoor unit and the indoor unit.
- The communication cable between the outdoor unit and the indoor unit.

CAUTION

- During installation, make first the refrigerant connections and then the electrical connections. If the unit is uninstalled, first disconnect the electrical cables and then the refrigerant connections.
- Connect the air conditioner to the earthing system before making the electrical connections.

NOTE

- Especially, if your outdoor unit is the one designed for Russian and European markets, consult the supply authority, if necessary, to estimate and reduce the supply system impedance before installation.

Air conditioning system examples

When using earth leakage circuit breaker (ELCB) for a single phase

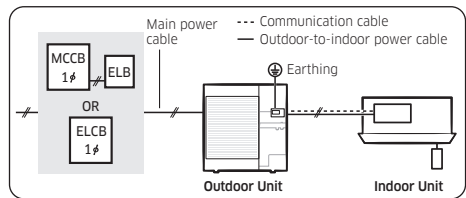

When using earth leakage circuit breaker (ELCB) for a 3-phase, 4-wire system (3P4W)

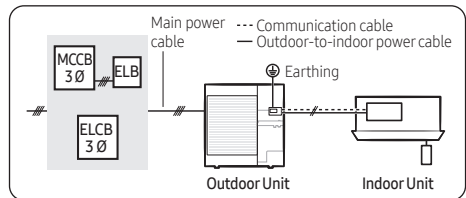

CAUTION

- If the outdoor unit is installed in a location vulnerable to an electric leak or submergence, make sure to install an ELCB.
- For the product that uses the R-32 refrigerant, be cautious not to generate any sparks near the product by keeping the following requirements:
 - Do not remove the fuses with power on.
 - Do not disconnect the power plug from the wall outlet with power on.
 - It is recommended to locate the outlet in a high position. Place the cords so that they are not tangled.

Installation Procedure

Connecting the main power cable

When using ELB for 1 phase and 3 phase

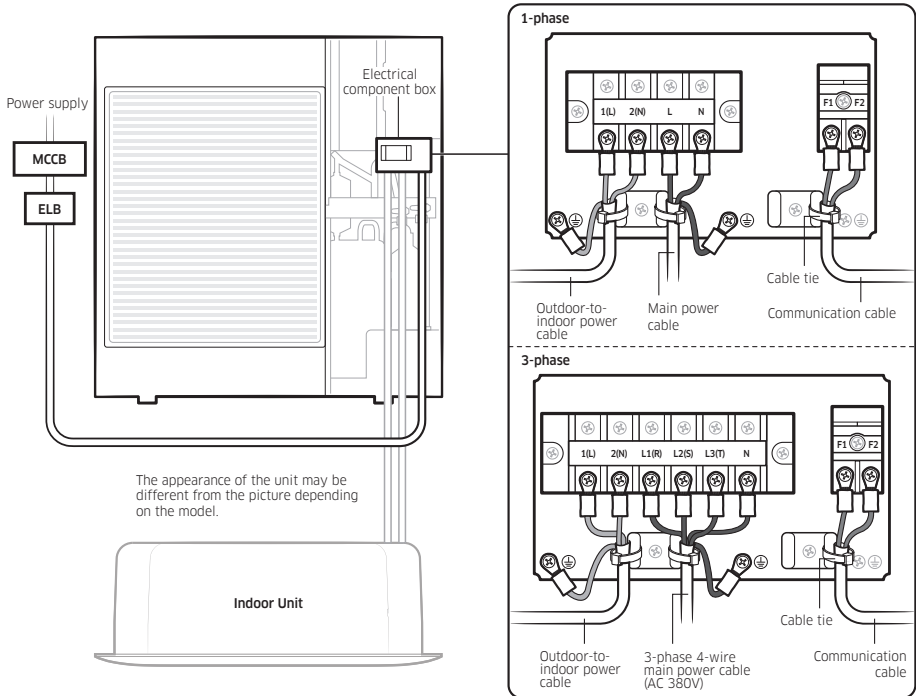

CAUTION

- You should connect the power cable into the power cable terminal and fasten it with a clamp.
- The unbalanced power must be maintained within 2% of supply rating.
- If the power is unbalanced greatly, it may shorten the life of the condenser. If the unbalanced power is exceeded over 4% of supply rating, the indoor unit is protected, stopped and the error mode indicates.
- To protect the product from water and possible shock, you should keep the power cables and the communication cable of the indoor and outdoor units within ducts. (with appropriate IP rating and material selection for your application)
- Ensure that main supply connection is made through a switch that disconnects all poles, with contact gap of at least 3 mm.
- Devices disconnected from the power supply should be completely disconnected in the condition of overvoltage category.
- Keep distances of 50 mm or more between power cable and communication cable. If the distance of 50mm or more cannot be kept, a double shielded cable (FROHH2R or LiCY type) must be used, connected to earth on a single side.

Main power terminal block specifications

- 1-phase terminal block specifications

(Unit: mm)

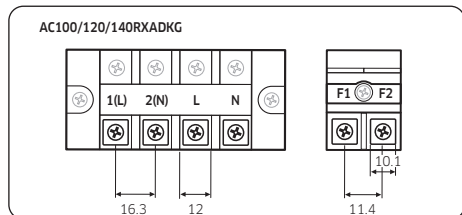

- 3-phase terminal block specifications

(Unit: mm)

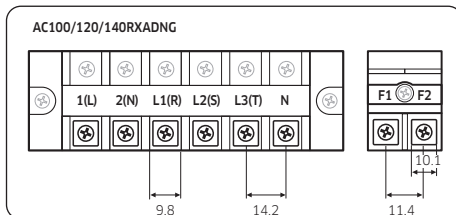

Main power cable specifications

The power cable is not supplied with air conditioner.

- Select the power supply cable in accordance with relevant local and national regulations.
- Wire size must comply with the applicable local and national code.
- Specifications for local wiring power cord and branch wiring are in compliance with local cord.

Single phase

Model		Outdoor unit				Input current (A)				Power supply	
Indoor unit	Outdoor unit	Hz	Voltage range (V)			Outdoor unit		Indoor unit	Total	MCA(A)	MFA(A)
			Rated	Min.	Max.	Cooling	Heating				
AC071BN4PKG/EU	AC071BXAPKG/EU	50	220 to 240	198	264	20	20	1.5	21.5	21.5	25.0
AC071BN6PKG/EU						20	20	1.5	21.5	21.5	25.0
AC071BNMPKG/EU						20	20	2.5	22.5	22.5	25.0
AC071BNAPKG/EU						20	20	1.0	21.0	21.0	25.0
AC071BNCPKG/EU						20	20	2.5	22.5	22.5	25.0
AC100BN4PKG/EU	AC100BXAPKG/EU	50	220 to 240	198	264	28	28	1.5	29.5	29.5	35.0
AC100BN6PKG/EU						28	28	1.5	29.5	29.5	35.0
AC100BNMPKG/EU						28	28	2.5	30.5	30.5	35.0
AC100BNTPKG/EU						28	28	1.0	29.0	29.0	35.0

Installation Procedure

3- phase

Model		Outdoor unit			Input current (A)			Powersupply			
Indoor unit	Outdoor unit	Hz	Voltage range (V)			Outdoor unit		Total	MCA(A)	MFA(A)	
			Rated	Min.	Max.	Cooling	Heating				
AC071BN4PKG/EU	AC071BXAPNG/EU	50	380 to 415	342	456.5	16.1	16.1	1.5	17.6	17.6	17.6
AC071BN6PKG/EU						16.1	16.1	1.5	17.6	17.6	17.6
AC071BNMPKG/EU						16.1	16.1	2.5	18.6	18.6	18.6
AC071BNAPKG/EU						16.1	16.1	1.0	17.1	17.1	17.1
AC071BNCPKG/EU						16.1	16.1	2.5	18.6	18.6	18.6
AC100BN4PKG/EU	AC100BXAPNG/EU					16.1	16.1	1.5	17.6	17.6	17.6
AC100BN6PKG/EU						16.1	16.1	1.5	17.6	17.6	17.6
AC100BNMPKG/EU						16.1	16.1	2.5	18.6	18.6	18.6
AC100BNTPKG/EU	AC120BXAPNG/EU					16.1	16.1	1.0	17.1	17.1	17.1
AC120BN4PKG/EU						16.1	16.1	1.5	17.6	17.6	17.6
AC120BN6PKG/EU						16.1	16.1	1.5	17.6	17.6	17.6
AC120BNMPKG/EU						16.1	16.1	2.5	18.6	18.6	18.6
AC140BN4PKG/EU	AC140BXAPNG/EU					16.1	16.1	1.5	17.6	17.6	17.6
AC140BN6PKG/EU						16.1	16.1	1.5	17.6	17.6	17.6
AC140BNMPKG/EU						16.1	16.1	2.5	18.6	18.6	18.6

NOTE

- Voltage range
 - Units are suitable for use on electrical systems where voltage supplied to unit terminal is not below or above listed range limits.
- Maximum allowable voltage variation between phases is 2%.
- Wire size & type must comply with the applicable local and national code.
 - Wire size: Based on the value of MCA.
 - Wire type: 60245 IEC57(IEC) or H05RN-F(CENELEC) grade or more.
- MFA is used to select the circuit breaker and the ground fault circuit interrupter (earth leakage circuit breaker).
- MCA represents maximum input current.
 - MFA represents capacity which may accept MCA
 - Abbreviations
MCA: Min. Circuit Amps. (A)
MFA: Max. Fuse Amps. (A)

- This equipment complies with IEC 61000-3-12 provided that the short-circuit power S_{sc} is greater than or equal to $S_{sc} (*2)$ at the interface point between the user's supply and the public system. It is the responsibility of the installer or user of the equipment to ensure, by consultation with the distribution network operator if necessary, that the equipment is connected only to a supply with a short-circuit power S_{sc} greater than or equal to $S_{sc}(*2)$.

Model	S_{sc} [MVA]
AC071BXAPNG/EU	1.4
AC100BXAPNG/EU AC120BXAPNG/EU AC140BXAPNG/EU	1.6

Silence mode controller wiring diagram

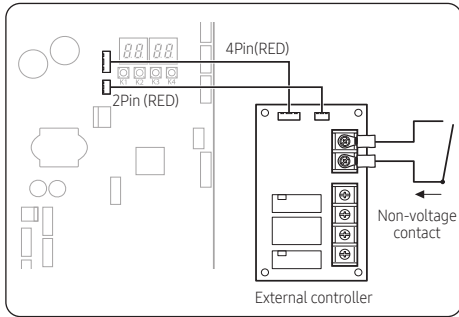

Connecting the outdoor-to-indoor power cable and the communication cable

1-phase

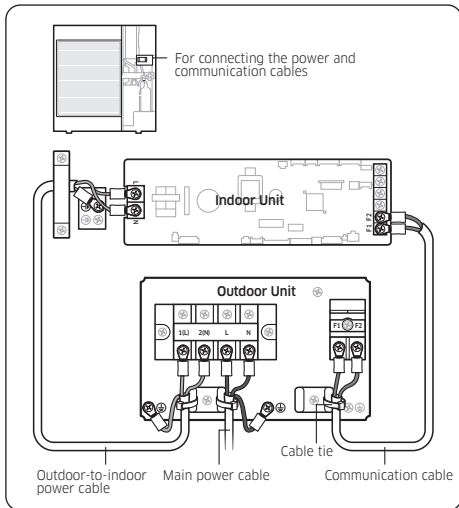

3-phase

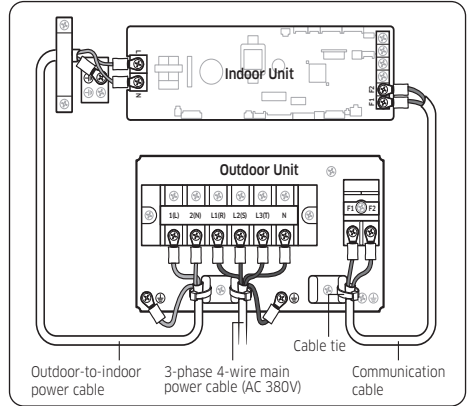

NOTE

- Lay the electrical wiring so that the front cover does not rise up when doing wiring work and attach the front cover securely.
- Ground wire for the indoor unit and outdoor unit connection cable must be clamped to a soft copper tin-plated eyelet terminal with M4 screw hole (NOT SUPPLIED WITH UNIT ACCESSORIES).

Installation Procedure

Outdoor-to-indoor power terminal specifications

- Connect the cables to the terminal board using the compressed ring terminal.
- Cover a solderless ring terminal and a connector part of the power cable and then connect it.

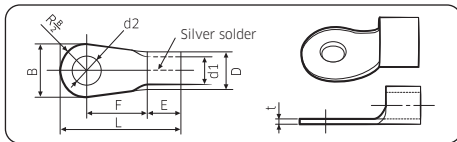

Nominal dimensions for cable (mm ²)	Nominal dimensions for screw (mm)	B		D		d1		E	F	L	d2		t
		Standard dimension (mm)	Allowance (mm)	Standard dimension (mm)	Allowance (mm)	Standard dimension (mm)	Allowance (mm)				Standard dimension (mm)	Allowance (mm)	
4/6	4	9.5	±0.2	5.6	+0.3 -0.2	3.4	±0.2	6	5	20	4.3	+0.2 0	0.9
	8	15									8.4	+0.4 0	
10	8	15	±0.2	7.1	+0.3 -0.2	4.5	±0.2	7.9	9	30	8.4	+0.4 0	1.15
16	8	16	±0.2	9	+0.3 -0.2	5.8	±0.2	9.5	13	33	8.4	+0.4 0	1.45
25	8	12	±0.3	11.5	+0.5 -0.2	7.7	±0.2	11	15	34	8.4	+0.4 0	1.7
	8	16.5							13		8.4		
35	8	16	±0.3	13.3	+0.5 -0.2	9.4	±0.2	12.5	13	38	8.4	+0.4 0	1.8
	8	22							13		43	8.4	
50	8	22	±0.3	13.5	+0.5 -0.2	11.4	±0.3	17.5	14	50	8.4	+0.4 0	1.8
70	8	24	±0.4	17.5	+0.5 -0.4	13.3	±0.4	18.5	20	51	8.4	+0.4 0	2.0

- Connect the rated cables only.
- Connect using a driver which is able to apply the rated torque to the screws.
- If the terminal is loose, fire may occur caused by arc. If the terminal is connected too firmly, the terminal may be damaged.

Tightening torque (N-m)	
M4	0.8 to 1.2
M5	2.0 to 3.0

- 1 N-m = 10 kgf-cm

⚠ CAUTION

- When connecting cables, you can connect the cables to the electrical part or connect them through the holes below depending on the spot.
- Connect the communication cable between the indoor and outdoor units through a conduit to protect against external forces, and feed the conduit through the wall together with refrigerant piping.
- Remove all burrs at the edge of the knock-out hole and secure the cable to the outdoor knock-out using lining and bushing with an electrical insulation such as rubber and so on.
- Must keep the cable in a protection tube.
- Keep distances of 50mm or more between power cable and communication cable.
- When the cables are connected through the hole, remove the knock-out piece.

Outdoor-to-indoor power and communication cables specifications

Indoor power supply		
Power supply	Max/Min (V)	Indoor power cable
1ø, 220-240V, 50 Hz	±10%	Cassette, RAC, Console : 0.75 mm ² †, 3 wires Duct, Ceiling : 1.5 mm ² †, 3 wires
Communication cable		
0.75 mm ² †, 2 wires		

- Power supply cords of parts of appliances for outdoor use shall not be lighter than polychloroprene sheathed flexible cord. (Code designation IEC:60245 IEC 57 / CENELEC: H05RN-F or IEC:60245 IEC 66 / CENELEC: H07RN-F)
- When installing the indoor unit in a computer room or net work room, use the double shielded (tape aluminium / polyester braid + copper) cable of FROHH2R type or LIYCY.

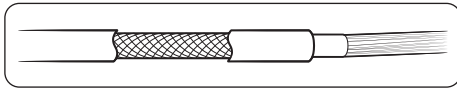

Step 5 Optional: Extending the power cable

- Prepare the following tools.

Tools	Spec	Shape
Crimping pliers	MH-14	
Connection sleeve (mm)	20 x Ø6.5 (H x OD)	
Insulation tape	Width 19 mm	
Contraction tube (mm)	70 x Ø8.0 (L x OD)	

- As shown in the figure, peel off the shields from the rubber and wire of the power cable.
 - Peel off 20 mm of cable shields from the pre-installed tube.

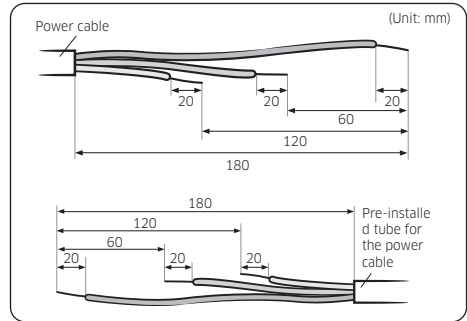

⚠ CAUTION

- For information about the power cable specifications for indoor and outdoor units, refer to the installation manual.
 - After peeling off cable wires from the pre-installed tube, insert a contraction tube.
- Insert both sides of core wire of the power cable into the connection sleeve.
 - Method 1:** Push the core wire into the sleeve from both sides.
 - Method 2:** Twist the wire cores together and push it into the sleeve.

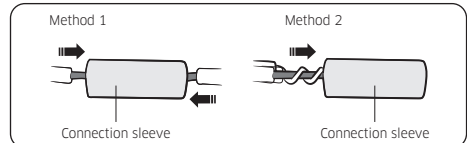

⚠ CAUTION

- If cable wires are connected without using connecting sleeves, their contact area becomes reduced, or corrosion develops on the outer surfaces of the wires (copper wires) over a long time. This may cause an increase of resistance (reduction of passing current) and consequently may result in a fire.

Installation Procedure

- 4 Using a crimping tool, compress the two points and flip it over and compress another two points in the same location.
- The compression dimension should be 8.0.

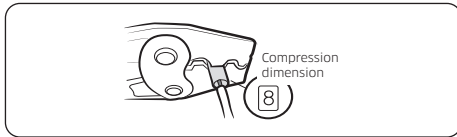

- After compressing it, pull both sides of the wire to make sure it is firmly pressed.

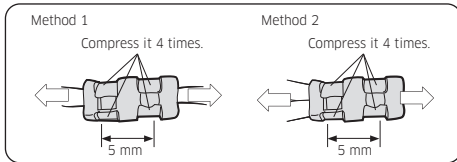

- 5 Apply heat to the contraction tube to contract it.

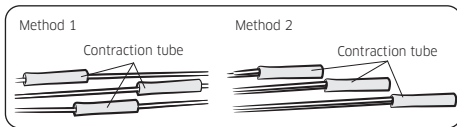

- 6 Wrap it with the insulation tape twice or more and position your contraction tube in the middle of the insulation tape.

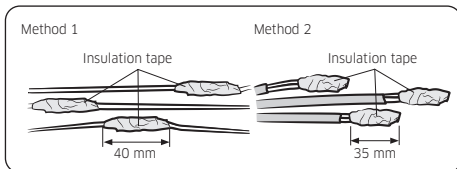

- 7 After tube contraction work is completed, wrap it with the insulation tape to finish. Three or more layers of insulation are required.

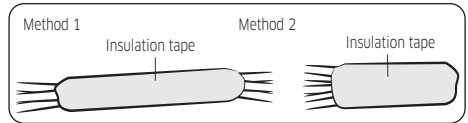

CAUTION

- Make sure that the connection parts are not exposed to outside.
- Be sure to use insulation tape and a contraction tube made of approved reinforced insulating materials that have the same level of withstand voltage with the power cable. (Comply with the local regulations on extensions.)

WARNING

- In case of extending the electric wire, please DO NOT use a round-shaped Pressing socket.
 - Incomplete wire connections can cause electric shock or a fire.

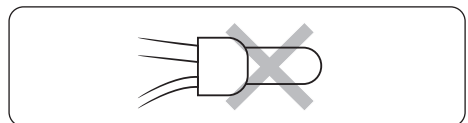

Step 6 Connecting the refrigerant pipe

Items	Maximum allowable length			
	Single Installation		DPM Installation	
Applicable outdoor unit models	AC071BXAPKG AC071BXAPNG	AC100BXAPKG AC100BXAPNG AC120BXAPNG AC140BXAPNG	AC071BXAPKG AC071BXAPNG	AC100BXAPKG AC100BXAPNG AC120BXAPNG AC140BXAPNG
Total pipe length (L1+...+Ln+1+a+b)	-	-	55 m	85 m
Main pipe (L1)	55 m	85 m	35 m	55 m
Max. distance among indoor units (D)	-	-	10 m	10 m
Max. length after branch	-	-	15 m	15 m
Max. height difference between outdoor and indoor units (h1)	30 m	30 m	30 m	30 m
Max. height difference among indoor units(h2)	-	-	0.5 m	0.5 m
Max Pipe length difference among indoor units after branch [L2-L3 or L2-L4 or L2-L5 or a-b or (a+L2)-(b+L4) or (a+L3)-(b+L5)]	-	-	5 m	5 m

- "n" means the number of indoor unit connection of DPM.

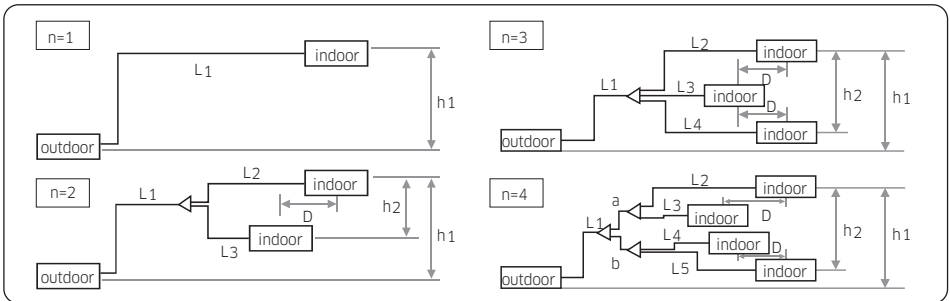

Installation Procedure

⚠ CAUTION

- Be sure to use C1220T-1/2H (Semi-hard) pipe for more than $\varnothing 19.05$ mm. If you use C1220T-O (Soft) pipe for $\varnothing 19.05$ mm, the pipe may burst open, which can result in an injury.

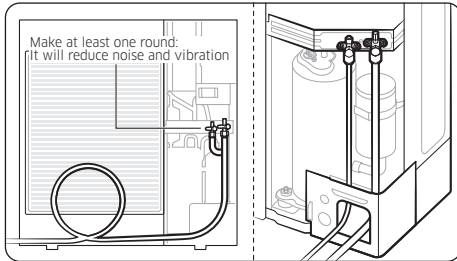

- The appearance of the unit may be different from the diagram depending on the model.

⚠ CAUTION

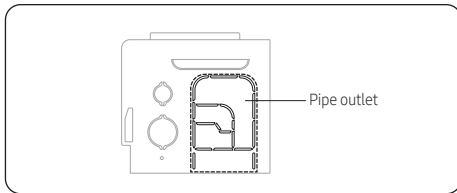

- Cut the pipe outlet to the exact pipe size. In addition, remove foreign substances and burres around the outlet.
- Perform cutting with only a cutter (ex. nipper) and never tap with a hammer near the pipe outlet. Otherwise, it may cause product damage such as warping of the cabinet.
- After connecting the pipes with Pipe outlet, plug the space around the pipes.
- After connecting the pipes, proceed exactly as directed in the guide to prevent interference with the internal parts.
- Tighten the nuts to the specified torques. If overtightened, the nuts could be broken so refrigerant may leak.
- Protect or enclose refrigerant tubing to avoid mechanical damage.
- After installing pipes, block the unused knock hole to prevent small animal from entering. However, the radiant heat hole(A) should be able to intake air.

Step 7 Optional: Cutting and flaring the pipes

- 1 Make sure that you have the required tools available. (pipe cutter, reamer, flaring tool, and pipe holder)
- 2 If you wish to shorten the pipes, cut it with a pipe cutter, taking care to ensure that the cut edge remains at a 90° angle with the side of the pipe. Refer to the illustrations below for examples of edges cut correctly and incorrectly.

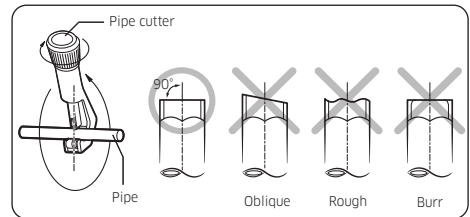

- 3 To prevent any gas from leaking out, remove all burrs at the cut edge of the pipe, using a reamer.
- 4 Slide a flare nut on to the pipe and modify the flare.

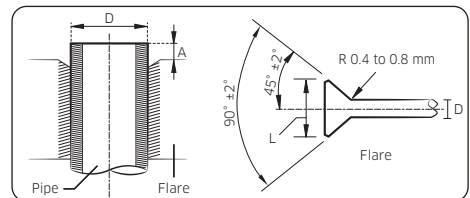

Outer diameter (D)	Depth (A)	Flare dimension (L)
ø6.35 mm	1.3mm	8.7 to 9.1 mm
ø9.52 mm	1.8mm	12.8 to 13.2 mm
ø12.70 mm	2.0mm	16.2 to 16.6 mm
ø15.88 mm	2.2mm	19.3 to 19.7 mm
ø19.05 mm	2.2mm	23.6 to 24.0 mm

- 5 Check that the flaring is correct, referring to the illustrations below for examples of incorrect flaring.

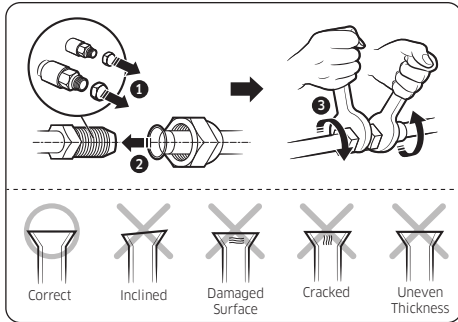

⚠ CAUTION

- Keep the piping length at a minimum to minimize the additional refrigerant charge due to piping extension.
- When connecting the pipes, make sure that surrounding objects do not interfere with or contact them to prevent refrigerant leakage due to physical damage.
- Make sure that the spaces where the refrigerant pipes are installed comply with national gas regulations.
- Be sure to perform works such as additional refrigerant charging and pipe welding under the conditions of good ventilation.
- Be sure to perform welding and piping works for mechanical connections under the conditions that the refrigerant does not circulate.
- When reconnecting the pipes, make sure to perform flared-jointing newly to prevent refrigerant leakage.
- When working on the refrigerant pipes and the flexible refrigerant connectors, be careful that they are not damaged physically by surrounding objects.
- For installation with handling the R-32 refrigerant, use the special tools for the R32 refrigerant (manifold gauge, vacuum pump, charging hose, etc.).
- During tests never pressurize the appliances with a pressure higher than the maximum allowable pressure (as indicated on the nameplate of the unit).
- Never directly touch any accidental leaking refrigerant. This could result in severe wounds caused by frostbite.
- Never install a dryer to this unit in order to guarantee its lifetime.
- If the pipes require brazing ensure that OFN (Oxygen Free Nitrogen) is flowing through the system.

- Nitrogen blowing pressure range is 0.02 to 0.05 MPa.
- If you need a pipe longer than specified in piping codes and standards, you must add refrigerant to the pipe. Otherwise, the indoor unit may freeze.
- While removing burrs, put the pipe face down to make sure that the burrs do not get in to the pipe.

Step 8 Installing oil traps

Check the following list and install an oil trap.

- Based on cooling operation, install it on the gas side pipe only.
- Install the oil trap only in between the outdoor unit and the first branch joint and it should be installed at every 10 m.
- Radius of curvature (R) on the oil trap are as follows;

Pipe diameter (D, mm)	12.70	15.88	19.05	22.23	25.40	28.60	31.75
Radius of curvature (R, mm)	25 and over	32 and over	38 and over	41 and over	51 and over	57 and over	60 and over

- Height of the oil trap (H): $4R \leq H \leq 6R$
- When the indoor unit is installed at a higher place than the outdoor unit

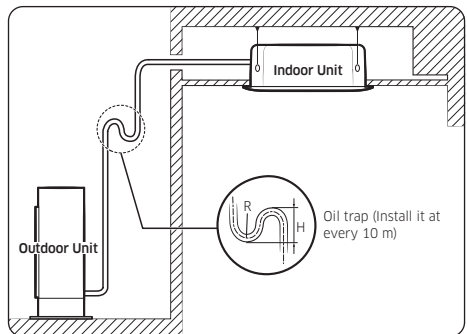

Installation Procedure

Step 9 Connecting up and removing air in the circuit

⚠ CAUTION

- When installing, make sure there is no leakage. When recovering the refrigerant, ground the compressor first before removing the connection pipe. If the refrigerant pipe is not properly connected and the compressor works with the service valve open, the pipe inhales the air and it makes the pressure inside of the refrigerant cycle abnormally high. It may cause explosion and injury.
- The air in the indoor unit and in the pipe must be evacuated. If air remains in the refrigerant pipes, it will affect the compressor either reduce cooling/heating capacity or lead to a malfunction.
- Use manifold gauge and vacuum pump as shown at the right figure.
- Make sure that both manifold gauge and vacuum pump are compatible with R-32.

- 1 Connect each assembly pipe to the appropriate valve on the outdoor unit and tighten the flare nut.
- 2 Referring to the illustration below, tighten the flare nut on section D first manually and then with a torque wrench, applying the following torque.

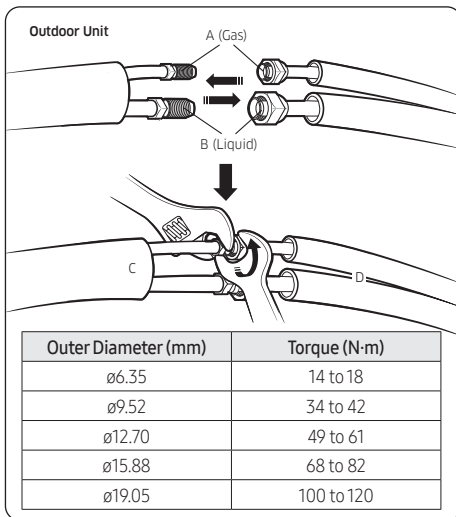

- 3 Connect the charging hose of low pressure side of manifold gauge to the packed valve having a service port as shown at the figure.

⚠ CAUTION

- The designs and shape are subject to change according to the model.
- 4 Open the valve of the low pressure side(A) of manifold gauge anticlockwise.

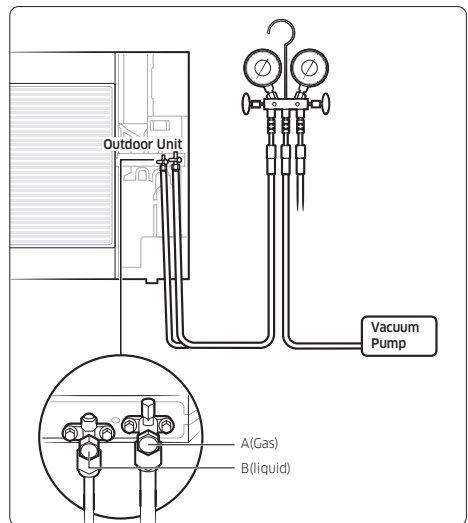

- 5 Purge the air from the system using vacuum pump for about 10 minutes.
 - Close the valve of the low pressure side of manifold gauge clockwise.
 - Make sure that pressure gauge shows -0.1 MPa (-76 cmHg) after about 10 minutes. This procedure is very important to avoid a gas leak.
 - Turn off the vacuum pump.
 - Remove the hose of the low pressure side of manifold gauge.
- 6 Open the stop valve of both liquid and gas sides.
- 7 Mount the valve stem nuts and the service port cap to the valve, and tighten them at the torque of 18 N·m with a torque wrench.

- 8 Check for gas leakage.
- At this time, especially check for gas leakage from the 3-way valve's stem nuts(A port), and from the service port cap.

CAUTION

- Connect the indoor and outdoor units using pipes with flared connections (not supplied). For the lines, use insulated, unwelded, degreased and deoxidized copper pipe, (Cu DHP type to ISO 1337 or UNI EN 12735-1), suitable for operating pressures of at least 4200 kPa and for a burst pressure of at least 20700 kPa. Copper pipe for hydro-sanitary applications is completely unsuitable.
- For sizing and limits (height difference, line length, max. bends, refrigerant charge, etc.) see "Connecting refrigerant pipe section".

Step 10 Adding refrigerant (R-32)

Precautions on adding the R-32 refrigerant

In addition to the conventional charging procedure, the following requirements shall be kept.

- Make sure that contamination by other refrigerants does not occur for charging.
- To minimize the amount of refrigerant, keep the hoses and lines as short as possible.
- The cylinders shall be kept upright.
- Make sure that the refrigeration system is earthed before charging.
- Label the system after charging, if necessary.
- Extreme care is required not to overcharge the system.
- Before recharging, the pressure shall be checked with nitrogen blowing.
- After charging, check for leakage before commissioning.
- Be sure to check for leakage before leaving the work area.
- The outdoor unit is loaded with sufficient refrigerant for the standard piping. Thus, refrigerant must be added if the piping is lengthened. This operation can only be performed by a qualified refrigeration specialist. To determine the quantity of refrigerant charge, see **Calculating the quantity of refrigerant to add** on page 25.

- 1 Check if the stop valve is closed completely.
- 2 Charge the refrigerant through the service port of the liquid stop valve.

NOTE

- Do not charge the refrigerant through the service port of the gas stop valve.
- 3 If you have any difficulty charging the refrigerant as described in the steps above, take the following steps:
 - a Open the liquid stop valve and gas stop valve.
 - b Operate the air conditioner by pressing the K2 key on the outdoor unit PCB.
 - c After about 30 minutes, charge the refrigerant through the service port of the gas stop valve.

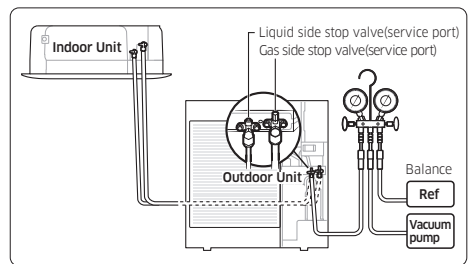

Important information: regulation regarding the refrigerant used

This product contains fluorinated greenhouse gases. Do not vent gases into the atmosphere.

CAUTION

- Inform user if the system contains 5 tCO₂e or more of fluorinated greenhouse gases. In this case, it must be checked for leakage at least once every 12 months, according to regulation No. 517/2014. This activity must be covered by qualified personnel only.
- In the case of the situation above, the installer (or authorized person with responsibility for final check) must provide a maintenance book, with all the information recorded, according to REGULATION (EU) No. 517/2014 OF THE EUROPEAN PARLIAMENT AND OF THE COUNCIL of 16 April 2014 on fluorinated greenhouse gases.

Installation Procedure

Please fill in the following with indelible ink on the refrigerant charge label supplied with this product and on this manual.

- ①: The factory refrigerant charge of the product.
- ②: The additional refrigerant amount charged in the field.
- ① + ②: The total refrigerant charge.

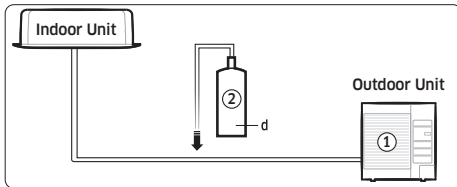

Unit	kg	tCO ₂ e
①, a		
②, b		
① + ②, c		

Refrigerant type	GWP value
R-32	675

- GWP: Global Warming Potential
- Calculating tCO₂e : kg x GWP / 1000

NOTE

- Factory refrigerant charge of the product: see unit name plate
- Additional refrigerant amount charged in the field (Refer to the above information for the quantity of refrigerant replenishment.)
- Total refrigerant charge
- Refrigerant cylinder and manifold for charging

CAUTION

- The filled-out label must be adhered in the proximity of the product charging port (e.g. onto the inside of the stop valve cover).
- Make sure that the total refrigerant charge does not exceed (A), the maximum refrigerant charge, which is calculated in the following formula: Maximum refrigerant charge (A) = factory refrigerant charge (B) + maximum additional refrigerant charge due to piping extension (C).

(Unit : g)

Model	A	B	C
AC071BXAPKG	3825	2700	1125
AC071BXAPNG			
AC100BXAPKG	5975	3500	2475
AC100BXAPNG			
AC120BXAPNG			
AC140BXAPNG			

Charging the refrigerant under conditions of liquid by using a liquid pipe

It is necessary for recharging under conditions of liquid. When recharging refrigerant from the refrigerant cylinder to the equipment, follow the instructions below.

- Before recharging, check whether the cylinder has a siphon or not. There are two ways to recharge the refrigerant.

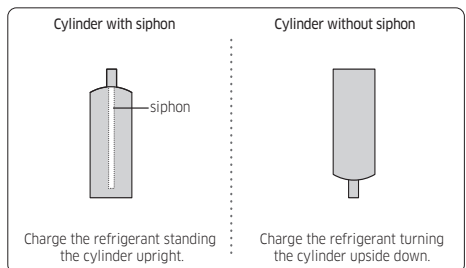

NOTE

- During the measuring operation of refrigerant quantity added use an electronic balance. If cylinder doesn't have siphon, upset it.

Calculating the quantity of refrigerant to add

The quantity of additional refrigerant is variable according to the installation situation. Thus, make sure the outdoor unit situation before adding refrigerant. This operation can only be performed by a qualified refrigeration specialist.

Single installation outdoor unit

Model	Interconnection pipe length (m)		
	0-30	30-55	55-85
AC071BXAPKG	0	+45 g/m over 30 m	+45 g/m over 30 m
AC071BXAPNG			
AC100BXAPKG	0		
AC100BXAPNG			
AC120BXAPNG			
AC140BXAPNG			
AC140BXAPNG			

DPM installation outdoor unit

Model	Diameter of L1, a & b pipe	Installation condition	Amount of additional refrigerant charging
AC071BXAPKG	Φ9.52	L1 + ... + Ln+1 ≤ 55 m	(L1+a+b-5) x 30 [g] + (L2 +...+Ln+1) x 20 [g] If (L1+a+b)<5m, (L2 +...+Ln+1) x 20 [g]
AC071BXAPNG			
AC100BXAPKG	Φ9.52	L1 + ... + Ln+1 ≤ 85 m	(L1+a+b-5) x 30 [g] + (L2 +...+Ln+1) x 25 [g] If (L1+a+b)<5m, (L2 +...+Ln+1) x 25 [g]
AC100BXAPNG			
AC120BXAPNG			
AC120BXAPNG			
AC140BXAPNG			

- "n" means the number of indoor unit connection of DPM.

Installing DPM

DPM allowable Outdoor and indoor unit models

DPM allowable Outdoor and Indoor unit models			
Outdoor unit	2-Indoor units connection	3-Indoor units connection	4-Indoor units connection
	Indoor Unit	Indoor Unit	Indoor Unit
AC071BXAP*G	AC035BN*PKG	-	-
AC100BXAP*G	AC052BN*PKG	AC035BN*PKG	-
AC120BXAP*G	-	-	AC035BNNPKG AC035BNMPKG
AC140BXAP*G	AC071BN*PKG	AC052BN*PKG	AC035BNNPKG AC035BNMPKG



CAUTION

- AC035BNAPKG is not allowed to be installed as 4-Indoor units connection due to excess of the maximum quantity of refrigerant.
- Installation of multiple indoor units should consist of units that have the same capacity.
e.g. When you install the AC100BXAPKG outdoor unit as DPM combination such as 2 or 3 indoor units connection, only the combination of two AC052BN*PKG or three AC035BN*PKG is available.

Space requirements for indoor and outdoor units and piping installation

(Refer to page 7-10 installation specification.)

- Two indoor units should be installed in one area which is not divided by a wall.
- The distance between two indoor units should be within a straight-line of 10m.
- After branching, the distance between the piping connected to the two indoor units should be within 5m.
- The height difference between two units should be within 0.5m.
- Use the joint KIT that is only for DPM. (Please refer to the table below)

DPM KIT	2-Indoor units connection	3-Indoor units connection	4-Indoor units connection
		MXJ-2D2509K	MXJ-3D2509K

Installation Procedure

Connecting communication line and wired remote controller

- In case of 2 indoor units connection

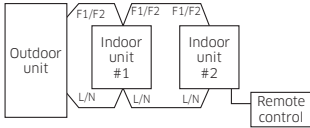

- In case of 3 indoor units connection

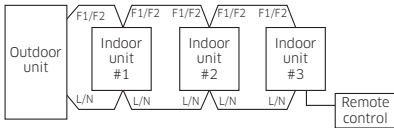

- In case of 4 indoor units connection

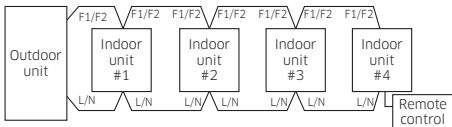

- The wired remote controller can be used with any of the DPM indoor units.

Operation and specification

- The two, the three, or the four sets of the indoor units with DPM installation which are controlled by wired and wireless remote controller work equally. (All controls such as ON/OFF, cooling/heating/dehumidification/ventilation, high/ medium/low wind are equally applied.)
- Thermo OFF which stops when indoor temperature reaches set temperature works by the average sensor value of the indoor temperature of the all indoor units.
- When one of the several indoor units has a problem, they protect operation or stop working.

Instruction for installation and operation

- You should install the DPM according to the above installation specification and eliminate the factors that give electrical load to the both indoor units when installing and operating. (Heater / window / front door / ventilation / partition that divides space)
- You should provide sufficient instructions about the operation method and specification features to users and fill in caution phrases on wired remote controller when necessary.
 - <The air-conditioners in this area are special type to be controlled simultaneously.>

Set up indoor quantity by key switch(K1, K2)

- Press and hold K1 switch to enter the setting mode on the number of the installed indoor unit : Check "A0" sign on 7-segment
 - Press K2 switch to set the number of the installed indoor unit :
 - EX) If there are two indoor units, press K2 switch twice, and check "A2" sign on 7-segment.
 - If there are three indoor units, press K2 switch three times, and check "A3" sign on 7-segment.
 - If there are four indoor units, press K2 switch four times, and check "A4" sign on 7-segment.
 - Press K1 switch to complete setting the number of the installed indoor unit : Check "AA" sign on 7-segment.

Step 11 Performing the gas leak test

LEAK TEST WITH NITROGEN (before opening valves)

In order to detect basic refrigerant leaks, before recreating the vacuum and recirculating the R-32, it is the responsibility of the installer to pressurize the whole system with nitrogen (using a cylinder with pressure reducer) at a pressure Above 0.2MPa, less than 4MPa (gauge).

LEAK TEST WITH R-32 (after opening valves)

Before opening valves, discharge all the nitrogen from the system and create vacuum. After opening valves check for leaks using a leak detector for refrigerant R-32.

Once you have completed all the connections, check for possible leaks using refrigerant leak detector specifically designed for HFC refrigerants.

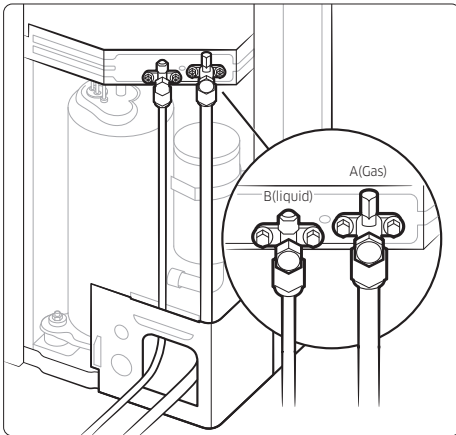

- The designs and shape are subject to change according to the model.

Step 12 Draining the water naturally

When using the air conditioner in the heating mode, ice may accumulate. During de-icing (defrost operation), the defrosting water must be drained off safely.

- Do not install a drain hose, a drain plug and a cap. (Let the water drain naturally).
- Ice may form on the ground. Take appropriate measures to prevent ice formation.

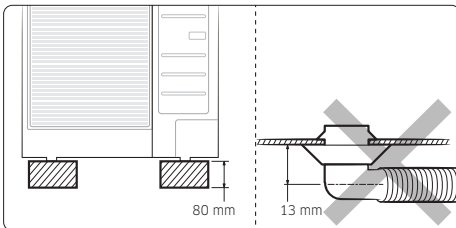

Step 13 Insulating the refrigerant pipes

Once you have checked that there are no leaks in the system, you can insulate the piping and hose.

- 1 To avoid condensation problems, place an insulator around each refrigerant pipe.

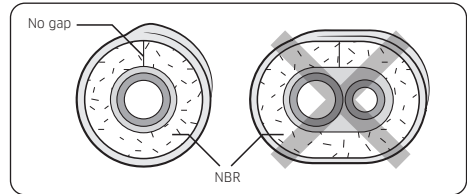

NOTE

- When insulate the pipe, be sure to overlap the insulation.
- The insulation has to be produced in full compliance of European regulation reg. EEC / EU 2037/ 2000 that requires the use of sheaths insulation form without using CFC and HCFC gases for health and the environment.

CAUTION

- 2 Select the insulation of the refrigerant pipe.
 - Insulate the gas side and liquid side pipe referring to the thickness according to the pipe size.
 - Less than Indoor temperature of 30°C and humidity of 85% is the standard condition. If installing in a high humidity condition, use one grade thicker insulator by referring to the table below. If installing in an unfavourable conditions, use thicker one.
 - Insulator's heat-resistance temperature should be more than 120°C.

Installation Procedure

Pipe	Pipe size (mm)	Insulation Type (Heating/Cooling)		Remarks
		Standard [Less than 30°C, 85%]	High humidity [over 30°C, 85%]	
		EPDM, NBR		
Liquid pipe	Ø6.35-Ø9.52	9 t	9 t	Internal temperature is higher than 120°C
	Ø12.7-Ø19.05	13 t	13 t	
Gas pipe	Ø6.35	13 t	19 t	
	Ø9.52-Ø19.05	19 t	25 t	

- When installing insulation in places and conditions below, use the same insulation that is used for high humidity conditions.
 - <Geological condition>
 - High humidity places such as shoreline, hot spring, near lake or river, and ridge (when the part of the building is covered by earth and sand.)
 - <Operation purpose condition>
 - Restaurant ceiling, sauna, swimming pool etc.
 - <Building construction condition>
 - The ceiling frequently exposed to moisture and cooling is not covered.
 - e.g. The pipe installed at a corridor of a dormitory and studio or near an exit that opens and closes frequently.
 - The place where the pipe is installed is highly humid due to the lack of ventilation system.

Step 14 Checking the earthing

If the power distribution circuit does not have a earthing or the earthing does not comply with specifications, an earthing electrode must be installed. The corresponding accessories are not supplied with the air conditioner.

- Select an earthing electrode that complies with the specifications given in the illustration.
- Connect the flexible hose to the flexible hose port.
 - In damp hard soil rather than loose sandy or gravel soil that has a higher earthing resistance.
 - Away from underground structures or facilities, such as gas pipes, water pipes, telephone lines and underground cables.
 - At least two metres away from a lightning conductor earthing electrode and its cable.

NOTE

- The earthing wire for the telephone line cannot be used to ground the air conditioner.

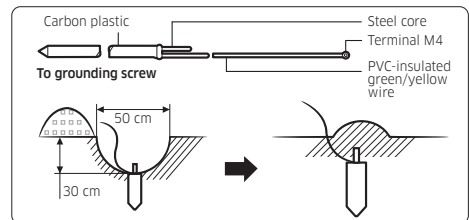

- Finish wrapping insulating tape around the rest of the pipes leading to the outdoor unit.
- Install a green/yellow color earthing wire:
 - If the earthing wire is too short, connect an extension lead in a mechanical way and wrap it with insulating tape (do not bury the connection).
 - Secure the earthing wire in position with staples.

NOTE

- If the earthing electrode is installed in an area with heavy traffic, its wire must be connected securely.
- Carefully check the installation by measuring the earthing resistance with a earth resistance tester. If the resistance is above the required level, drive the electrode deeper into the ground or increase the number of earthing electrodes.
 - Connect the earthing wire to the electrical component box inside of the outdoor unit.

Step 15 Performing final check and trial operation

- 1 Check the power supply between the outdoor unit and the auxiliary circuit breaker.
 - 1 phase power supply : L, N
 - 3 phase power supply : R, S, T, N
- 2 Check the indoor unit.
 - a Check that you have connected the power and communication cables correctly. (If the power cable and communication cables are mixed up or connected incorrectly, the PCB will be damaged.)
 - b Check that the thermistor sensor, drain pump/hose, and display are connected correctly.
- 3 Press K1 or K2 on the outdoor unit PCB to run the test mode and stop.

Key	Push type	Mode	Display			
			SEG1	SEG2	SEG3	SEG4
K1	Short	1st Heating test mode	F	1	8	8
		2nd Defrost test mode ¹⁾	F	3	8	8
		3rd End Key operation	8	8	8	8
K2	Short	1st Cooling test mode	F	2	8	8
		2nd Inverter check	F	4	8	8
		3rd Pump down	F	6	8	8
		4th Unusual	F	8	8	8
		5th Inverter Fault Detection (Comp#1) ²⁾	F	A	8	8
		6th Auto trial operation	F	C	8	8
		7th Auto check ³⁾ (Installation commissioning mode)	F	E	8	8
		8th End Key operation	8	8	8	8
K3	Short	1st Reset Release Eco mode	8	8	8	8

※ Defrost test mode

Condition 1: The outdoor temperature is below 10°C.

Condition 2: All the temperature conditions should meet the defrost conditions.

- 2) Indication on the display and action to take when an inverter fault is detected

	SEG1	SEG2	SEG3	SEG4	Action to take
Fault detection is in progress	F	1	8	8	-
OK	F	1	0	F	-
NG	F	1	A	0	PBA defect: Replace the PBA
Check	F	1	C	A	Manual inspection is required
Going into fault detection mode failed	F	1	F	L	Try fault detection again

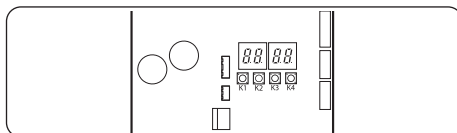

- 3) Auto check is not applied in this model.

- 4 After 12 minutes operation check discharged air temperature of indoor unit
 - Cooling mode (indoor unit check) → Inlet air temp. - Outlet air temp.: From 10°C to 12°C
 - Heating mode (indoor unit check) → Outlet air temp. - Inlet air temp.: From 11°C to 14°C
 - In heating mode, the indoor fan motor can remain off to avoid cold air blown into air-conditioned space.
- 5 How to reset the power supply of the outdoor unit and deactivate the eco mode (standby mode):
 - Outdoor unit types A, B : Refer to Outdoor unit dimensions on page 8.
 - Press K3 button over 1 sec to reset the power supply of the outdoor unit and deactivate the eco mode (standby mode).

※ Eco mode : Standby for minimizing power consumption

Installation Procedure

- 6 View mode: When the K4 switch is pressed, you can see information about our system state as below.
- For a function that is not supported, "-" is shown for SEG2, SEG3 or SEG4.

K4 short push	Display contents	SEG1	SEG2	SEG3	SEG4	Unit
1	Order frequency	1	Hundreds digit	Tens digit	Units digit	Hz
2	Current frequency	2	Hundreds digit	Tens digit	Units digit	Hz
3	The number of preset indoor units	3	Hundreds digit	Tens digit	Units digit	EA
4	Ambient temperature sensor	4	Hundreds digit or "-" ¹⁾	Tens digit	Units digit	°C or °F ²⁾
5	Compressor discharge sensor	5	Hundreds digit	Tens digit	Units digit	°C or °F ²⁾
6	Eva-Mid sensor	6	Hundreds digit or "-" ¹⁾	Tens digit	Units digit	°C or °F ²⁾
7	Condensor sensor	7	Hundreds digit or "-" ¹⁾	Tens digit	Units digit	°C or °F ²⁾
8	Current	8	Tens digit	Units digit	The first place of decimals	A
9	Outdoor fan RPM	9	Thousands digit	Hundreds digit	Tens digit	rpm
10	Target discharge temperature	A	Hundreds digit or "-" ¹⁾	Tens digit	Units digit	°C or °F ²⁾
11	EEV	B	Hundreds digit	Tens digit	Units digit	step
12	The capacity sum of indoor units	C	Tens digit	Unit digit	The first place of decimals	kW or kBtu/h ³⁾
13	Protective control	D	0: Cooling 1: Heating	Protective control 0: No Protective control 1: Freezing 2: Non-stop defrosting 3: Over-load 4: Discharge 5: Total electric current	Frequency status 0: Normal 1: Hold 2: Down 3: Up_limit 4: Down_limit	-
14	IPM temperature	E	Hundreds digit or "-" ¹⁾	Tens digit	Units digit	°C or °F ²⁾
15	The number of connected indoor units	F	Hundreds digit	Tens digit	Units digit	EA
16	ESC EEV(CAM)	G	Hundreds digit	Tens digit	Units digit	step
17	ESC IN sensor	H	Hundreds digit or "-" ¹⁾	Tens digit	Units digit	°C or °F ²⁾
18	ESC OUT sensor	I	Hundreds digit or "-" ¹⁾	Tens digit	Units digit	°C or °F ²⁾
19	View mode end	BLANK	BLANK	BLANK	BLANK	

¹⁾ Sub-zero temperatures are expressed as a minus, instead of hundreds digit.

²⁾ The temperature unit can be switched between Celsius and Fahrenheit through Setting outdoor unit option switches. (Default value is Celsius.)

³⁾ If the temperature unit is set to Fahrenheit through Setting outdoor unit option switches, the value is expressed in the unit of kBtu/h.

		Display contents	SEG1	SEG2	SEG3	SEG4
K4 long push	-	Main micom version	Year (Dec)	Month (Hex)	Date (Tens digit)	Date (Units digit)
	After short push 1	Inverter micom version	Year (Dec)	Month (Hex)	Date (Tens digit)	Date (Units digit)
	After short push 2	E2P version	Year (Dec)	Month (Hex)	Date (Tens digit)	Date (Units digit)
	After short push 3	Page 1 - AUTO Page 2 - (SEG1,2 - Indoor: "A","0") (SEG3,4 - Address : ex) 00)				
	After short push 4	Page 1 - MANU Page 2 - (SEG1,2 - Indoor: "A","0") (SEG3,4 - Address : ex) 00)				

Long push K4 (Main micom ver.) → short push 1 more (Inv. micom ver.) → short push 1 more (E2P ver.) → short push 1 more (Automatic address) → short push 1 more (Manual address) → short push 1 more (Main micom ver.) → → Long push K4 (View mode end)

7 Setting outdoor unit option switch and address manually

a Setting the option

- Press and hold K2 to enter the option setting. (Only available when the operation is stopped)
- If you enter the option setting, display will show the following.

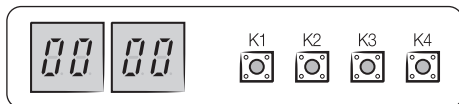

- Seg 1 and Seg 2 will display the number for selected option.
- Seg 3 and Seg 4 will display the number for set value of the selected option.
- If you have entered option setting, you can shortly press the K1 switch to adjust the value of the Seg 1, Seg 2 and select the desired option.

Example)

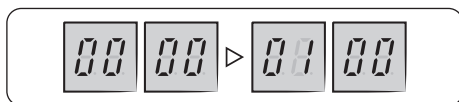

- If you have selected desired option, you can shortly press the K2 switch to adjust the value of the Seg 3, Seg 4 and change the function for the selected option.

Example)

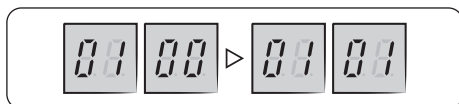

- After selecting the function for options, press and hold the K2 switch for 2 seconds. Edited value of the option will be saved when entire segments blinks and tracking mode begins.

Option item	Input unit	SEG1	SEG2	SEG3	SEG4	Function
Channel address	Main	0	0	A	U	Automatic setting (Factory default)
				00-15		Manual setting
Snow accumulation prevention control	Main	0	1	0	0	Disabled (Factory default)
				0	1	Enabled
Step for Silence mode	Main	0	2	0	0	Disabled (Factory default)
				0	1	Step1
				0	2	Step2
				0	3	Step3
Type of Silence mode	Main	0	3	0	0	Automatic Silence mode (Factory default)
				0	1	Manual Silence mode
Temperature unit	Main	0	4	0	0	Celsius (default)
				0	1	Fahrenheit
Not applicable	Main	0	5	0	0	Not applicable
				0	1	Not applicable
Current restriction rate 1)	Main	0	6	0	0	100% (Factory default)
				0	1	95%
				0	2	90%
				0	3	85%
				0	4	80%
				0	5	75%
				0	6	70%
				0	7	65%
				0	8	60%
				0	9	55%
				1	0	50%
1	1	100%				

Installation Procedure

Option item	Input unit	SEG1	SEG2	SEG3	SEG4	Function
Dedicated mode for cooling/heating	Main	0	7	0	0	Cooling / Heating operation (default)
				0	1	Cooling operation only
				0	2	Heating operation only

- ¹⁾ Current restriction rate : When restriction option is set, cooling and heating performance may decrease.

CAUTION

- Edited option will not be saved if you do not end the option setting as explained in above instruction.
- ✘ While you are setting the option, you may press and hold the K1 button to reset the value to previous setting.
- ✘ If you want to restore the setting to factory default, press and hold the K4 button while you are in the option setting mode.
 - If you press and hold the K4 button, setting will be restored to factory default but it doesn't mean that restored setting is saved. Press and hold the K2 button. When the segments shows that tracking mode is in progress, setting will be saved.

Extra Procedures

Pumping down refrigerant

WARNING

- After installing the product, be sure to perform leak tests on the piping connections. After pumping down refrigerant to inspect or relocate the outdoor unit, be sure to stop the compressor and then remove the connected pipes.
 - Do not operate the compressor for pump down when the refrigerant circuit is open due to a refrigerant leakage or a disconnected (or incorrectly connected) pipe. Failure to do so may cause air to flow into the compressor and a too high pressure can develop inside the refrigerant circuit, leading to an explosion or product malfunction.

Pump-down is an operation intended to collect all the system refrigerant in the outdoor unit. This operation must be carried out before disconnecting the refrigerant pipe in order to avoid refrigerant loss to the atmosphere.

- 1 Turn the system on in cooling with fan operating at high velocity and then let the compressor run for more than 5 minutes. (Compressor will immediately start, provided 3 minutes have elapsed since the last stop.)
- 2 Release the valve caps on High and Low pressure side.
- 3 Use L-wrench to close the valve on the high pressure side.
- 4 After approximately 2 minute, close the valve on the low pressure side.
- 5 Stop operation of the air conditioner by pressing the (Power) button on the indoor unit or remote control.

- 6 Disconnect the pipes.

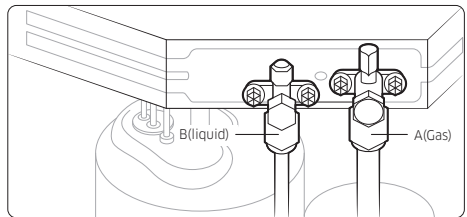

Relocating the indoor and outdoor units

- 1 Pump down refrigerant. See **Pumping down refrigerant** on page 32.
- 2 Disconnect the power supply only after rendering the system powerless from the mains power.
- 3 Disconnect the assembly cable from the indoor and outdoor units.
- 4 Remove the flare nuts connecting the indoor units and the pipes. At this time, cover the pipes of the indoor unit and the other pipes using a cap or vinyl plug to avoid foreign material entering.
- 5 Disconnect the pipes connected to the outdoor units. At this time, cover the valve of the outdoor units and the other pipes using a cap or vinyl plug to avoid foreign material entering. Note: Make sure you do not bend the connection pipes in the middle and store together with the cables.
- 6 Move the indoor and outdoor units to a new location.
- 7 Remove the mounting plate for the indoor unit and move it to a new location.

Using the stop valve

Opening the stop valve

- 1 Open the cap and turn the stop valve anticlockwise by using a hexagonal wrench.
- 2 Turn it until the axis is stopped.

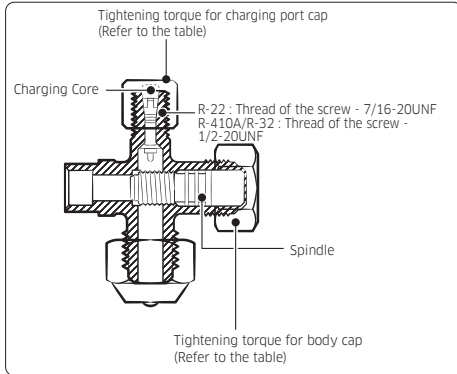

- 3 Tighten the cap securely.

Outer Diameter (mm)	Tightening torque	
	Body cap (N·m)	Charging port cap (N·m)
∅6.35	20 to 25	10 to 12
∅9.52	20 to 25	
∅12.70	25 to 30	
∅15.88	30 to 35	
Over ∅19.05	35 to 40	

(1 N·m=10 kgf·cm)

NOTE

- Do not apply excessive force to the stop valve and always use special instruments. Otherwise, the stopping box can be damaged and the back sheet can leak.
- If the watertight sheet leaks, turn the axis back by half, tighten the stopping box, then check the leakage again. If there is no leakage any more, tighten the axis entirely.

Closing the stop valve

- 1 Remove the cap.
- 2 Turn the stop valve clockwise by using a hexagonal wrench.
- 3 Tighten the axis until the valve reached the sealing point.
- 4 Tighten the cap securely.

CAUTION

- When you use the service port, always use a charging hose, too.
- Check the leakage of refrigerant gas after tightening the cap.
- Must use a spanner and wrench when you open/tighten the stop valve.

Maintenance Procedures

Performing the gas leak tests for repair

In case of repair of the refrigerant circuit, the following procedure must be kept to consider flammability.

- 1 Remove the refrigerant.
- 2 Purge the refrigerant circuit with inert gas.
- 3 Perform evacuation.
- 4 Purge the circuit again with inert gas.
- 5 Open the circuit.
- 6 Perform repair work.
- 7 Charge the system with refrigerant.
- 8 Flush the system with nitrogen blowing for safety.
- 9 Repeat the previous steps several times until no refrigerant is within the system.



CAUTION

- Compressed air or oxygen shall not be used.
- Flush the system with nitrogen blowing, fill the refrigerant until the working pressure is reached, ventilate to atmosphere, and then pull down to a vacuum state.
- For the final nitrogen blowing charge, the system shall be ventilated down to atmospheric pressure.
- The procedure is absolutely vital in case of brazing on the pipings.
- Make sure that the outlet of the vacuum pump is not closed to any ignition sources and there is ventilation available.
- Do not apply any permanent inductive or capacitance loads to the circuit without ensuring that this will not exceed the permissible voltage and current permitted for the air conditioner.

Decommissioning

The following requirements must be fulfilled before and while taking the decommissioning procedure:

- Before decommissioning, the worker shall be familiar with the product details.
 - The entire refrigerant shall be recovered safely.
 - Before starting the process, oil and refrigerant samples shall be taken just in case analysis is required for reuse.
 - Before starting the process, power supply must be available.
- 1 Be familiar with the equipment details.
 - 2 Isolate the system electrically.
 - 3 Before starting the process, make sure that:
 - Any mechanical equipment is available for handling refrigerant cylinders.
 - All PPE (personal protective equipment) is available for servicing.
 - The recovery process shall be supervised by a competent person.
 - The recovery equipment and cylinders comply with the standards.
 - 4 Lower the refrigeration system, if possible.
 - 5 If vacuuming is not possible, make a manifold so that refrigerant can be easily removed from the parts of the system.
 - 6 Make sure that the cylinders are placed on the scales before recovery.
 - 7 Run the recovery system in accordance with the manufacturer's instructions.
 - 8 Do not overcharge the cylinders. (No more than 80 %)
 - 9 Be sure to keep the cylinder within the maximum working pressure, even temporarily.
 - 10 After charging, make sure that the cylinders and the equipment are promptly removed from the site and all isolation valves are closed.
 - 11 Recovered refrigerant shall not be charged into other refrigeration system unless it is cleaned and checked.

Appendix

Troubleshooting

The table below list the self-diagnostic routines. For some of error codes, you must contact an authorized service centre. If an error occurs during the operation, it is displayed on the outdoor unit PCB LED, both MAIN PCB and INVERTER PCB.

No.	Error Code	Meaning	Remarks
1	E108	Error due to duplicated communication address	Check on repeated indoor unit main address
2	E121	Error on room temperature sensor of indoor unit (Short or Open)	Indoor unit Room Thermistor Open/Short
3	E122	Error on EVA IN sensor of indoor unit (Short or Open)	Indoor unit EVA_IN Thermistor Open/Short
4	E123	Error on EVA OUT sensor of indoor unit (Short or Open)	Indoor unit EVA_OUT Thermistor Open/Short
5	E153	Error on float switch (2nd detection)	Indoor unit Float Switch Open/Short Drain Pump operation Check
6	E154	Indoor fan error	Check on indoor unit indoor Fan operation
7	E198	Error on thermal fuse of indoor unit (Open)	Thermal Fuse Open Check of indoor unit Terminal Block
8	E201	Communication error between the indoor unit and outdoor unit (Pre-tracking failure or when the actual number of indoor units are different from the indoor unit quantity setting on the outdoor unit) Error due to communication tracking failure after initial power is supplied (The error occurs regardless of the number of units.)	Check indoor quantity setting in outdoor
9	E202	Communication error between indoor unit and outdoor unit (When there is no response from indoor units after tracking is completed)	Check electrical connection and setting between indoor unit and outdoor unit
10	E203	Communication error between the outdoor unit and main micom (For PF #4 to #6 controllers, error will be determined from the time when the compressor is turned on.)	Check electrical connection and setting between outdoor unit MAIN PBA - INVERTER PBA
11	E221	Error on outdoor temperature sensor (Short or Open)	Check Outdoor sensor Open / Short
12	E231	Error on outdoor COND OUT sensor (Short or Open)	Check Cond-Out sensor Open / Short
13	E251	Error on discharge temperature sensor of compressor 1 (Short or Open)	Check Discharge sensor Open / Short
14	E320	Error on OLP sensor (Short or Open)	Check OLP sensor Open / Short
15	E321	Error on ESC IN temperature sensor (Short or Open)	Check ESC IN sensor Open / Short
16	E322	Error on ESC OUT temperature sensor (Short or Open)	Check ESC OUT sensor Open / Short
17	E403	Compressor down due to freeze protection control	Check Outdoor Cond.
18	E404	System stop due to overload protection control	Check Comp. when it starts
19	E416	System stop due to discharge temperature	-
20	E422	Blockage detected on high pressure pipe during cooling operation	<ol style="list-style-type: none"> 1. Check if the service valve is open 2. Check for refrigerant leakage (pipe connections, heat exchanger) and charge refrigerant if necessary 3. Check if there's any blockage on the refrigerant cycle (indoor unit/outdoor unit) 4. Check if additional refrigerant has been added after pipe extension
21	E425	Reverse phase or open phase	Check whether 3 phase is reversed or opened.

Appendix

No.	Error Code	Meaning	Remarks
22	E440	Heating operation restricted at outdoor temperature over Theat_high value (default:30°C)	1. Check the range of temperature limited for heating operation 2. Check the outdoor temperature sensor
23	E441	Cooling operation restricted at outdoor temperature below Tcool_low value (default:0°C)	1. Check the range of temperature limited for cooling operation 2. Check the outdoor temperature sensor
24	E458	Fan speed error	FAN1 ERROR
25	E461	Error due to operation failure of inverter compressor	-
26	E462	System stop due to full current control	-
27	E463	Over current trip / PFC over current error	Check OLP sensor
28	E464	IPM Over Current(O.C)	1. Check if the service valve is open 2. Check the state of refrigerant 3. Check if connecting wire and the pipe are OK 4. Check the compressor
29	E465	Comp. Over load error	-
30	E466	DC-Link voltage under/over error	Check AC Power and DC Link Voltage
31	E467	Error due to abnormal rotation of the compressor or unconnected wire of compressor	Check Comp wire
32	E468	Error on current sensor (Short or Open)	Check Outdoor Inverter PBA.
33	E469	Error on DC-Link voltage sensor (Short or Open)	-
34	E470	Outdoor unit EEPROM Read/Write error (Option)	Check Outdoor EEPROM Data
35	E471	Outdoor unit EEPROM Read/Write error (H/W)	Check Outdoor EEPROM PBA
36	E474	Error on IPM Heat Sink sensor of inverter 1 (Short or Open)	Check Outdoor Inverter PBA.
37	E475	Error on inverter fan 2	FAN2 ERROR
38	E483	Overvoltage of H/W detect DC link	Check AC Power
39	E484	PFC Overload (Over current) Error	Check Outdoor Inverter PBA.
40	E485	Error on input current sensor of inverter 1 (Short or Open)	Check Outdoor EEPROM PBA
41	E488	Inverter input voltage sensor error	Check Outdoor Inverter PBA
42	E500	IPM over heat error on inverter 1	Check Outdoor Inverter PBA.
43	E507	Error due to high pressure switch open or compressor down by high pressure	-
44	E508	Smart install is not installed	-
45	E534	Blockage detected on high pressure pipe during heating operation.	1. Check if the service valve is open 2. Check if there's any blockage on the refrigerant cycle (indoor unit/outdoor unit) 3. Check the EEV connection and operation 4. Check if connecting wire and the pipe are OK 5. Check the compressor
46	E554	Gas leak detected	Check the refrigerant
47	E556	Error due to mismatching capacity of indoor and outdoor unit	Check the indoor and outdoor unit capacity
48	E557	DPM remote controller option error	Check the indoor option code
49	E563	Error due to mismatching indoor and outdoor unit	Check the outdoor EEPROM data and indoor option code
50	E590	Inverter EEPROM Checksum error	-

Technical specifications

Model	Net weight	Net dimension (W x D x H)
AC071BXAPKG	75.0 kg	940 mm x 330 mm x 998 mm
AC071BXAPNG	74.0 kg	940 mm x 330 mm x 998 mm
AC100BXAPKG	100.0 kg	940 mm x 330 mm x 1420 mm
AC100BXAPNG	100.0 kg	940 mm x 330 mm x 1420 mm
AC120BXAPNG	100.0 kg	940 mm x 330 mm x 1420 mm
AC140BXAPNG	100.0 kg	940 mm x 330 mm x 1420 mm

Samsung, PO Box 12987, Blackrock, Co. Dublin. IE
or Euro QA Lab. Saxony Way, Yateley, Hampshire GU46 6GG, UK



This appliance is filled with R-32.