

Air conditioner

Installation manual

AC***BN4PKG

- Thank you for purchasing this Samsung air conditioner.
- Before operating this unit, please read this manual carefully and retain it for future reference.



SAMSUNG

Contents

Safety Information	3
Installation Procedure	5
Step 1 Checking and preparing accessories	5
Step 2 Choosing the installation location	5
Step 3 Optional: Insulating the body of the indoor unit	8
Step 4 Installing the indoor unit	9
Step 5 Purging inert gas from the indoor unit	10
Step 6 Cutting and flaring the pipes	10
Step 7 Connecting the assembly pipes to the refrigerant pipes	11
Step 8 Performing the gas leak test	11
Step 9 Insulating the refrigerant pipes	12
Step 10 Installing the drain hose and drain pipe	13
Step 11 Performing the drainage test	14
Step 12 Connecting the power and communication cables	15
Step 13 Optional: Extending the power cable	16
Step 14 Setting the indoor unit addresses and the installation options	18
Step 15 Optional: Installing DPM (Digital Packaged Multi)	27
Step 16 Optional : Setting the Emergency Temperature Output (ETO) function	28
Step 17 Optional : LED Display indicator specifications when checking Wi-Fi Easy Setup and Wi-Fi status (This feature can be used when installing single Wi-fi kit)	29
Appendix	31
Troubleshooting	31

Safety Information

WARNING

- Hazards or unsafe practices that may result in severe personal injury or death.

CAUTION

- Hazards or unsafe practices that may result in minor personal injury or property damage.
- Carefully follow the precautions listed below because they are essential to guarantee the safety of the equipment.

WARNING

- Always disconnect the air conditioner from the power supply before servicing it or accessing its internal components.
- Verify that installation and testing operations are performed by qualified personnel.
- Verify that the air conditioner is not installed in an easily accessible area.

General information

WARNING

- Carefully read the content of this manual before installing the air conditioner and store the manual in a safe place in order to be able to use it as reference after installation.
 - For maximum safety, installers should always carefully read the following warnings.
 - Store the operation and installation manual in a safe location and remember to hand it over to the new owner if the air conditioner is sold or transferred.
 - This manual explains how to install an indoor unit with a split system with two SAMSUNG units. The use of other types of units with different control systems may damage the units and invalidate the warranty. The manufacturer shall not be responsible for damages arising from the use of non compliant units.
 - The manufacturer shall not be responsible for damage originating from unauthorized changes or the improper connection of electric and requirements set forth in the "Operating limits" table, included in the manual, shall immediately invalidate the warranty.
 - The air conditioner should be used only for the applications for which it has been designed: the indoor unit is not suitable to be installed in areas used for laundry.
- Do not use the units if damaged. If problems occur, switch the unit off and disconnect it from the power supply.
 - In order to prevent electric shocks, fires or injuries, always stop the unit, disable the protection switch and contact SAMSUNG's technical support if the unit produces smoke, if the power cable is hot or damaged or if the unit is very noisy.
 - Always remember to inspect the unit, electric connections, refrigerant tubes and protections regularly. These operations should be performed by qualified personnel only.
 - The unit contains moving parts, which should always be kept out of the reach of children.
 - Do not attempt to repair, move, alter or reinstall the unit. If performed by unauthorized personnel, these operations may cause electric shocks or fires.
 - Do not place containers with liquids or other objects on the unit.
 - All the materials used for the manufacture and packaging of the air conditioner are recyclable.
 - The packing material and exhaust batteries of the remote controller(optional) must be disposed of in accordance with current laws.
 - The air conditioner contains a refrigerant that has to be disposed of as special waste. At the end of its life cycle, the air conditioner must be disposed of in authorised centres or returned to the retailer so that it can be disposed of correctly and safely.
 - Wear protective equipment (such as safety gloves, goggles, and headgear) during installation and maintenance works. Installation/repair technicians may be injured if protective equipment is not properly equipped.
 - Do not use means to accelerate the defrost operation or to clean, other than those recommended by Samsung.
 - Do not pierce or burn.
 - Be aware that refrigerants may not contain an odour.

Installing the unit

WARNING

IMPORTANT: When installing the unit, always remember to connect first the refrigerant tubes, then the electrical lines.

- Always disassemble the electric lines before the refrigerant tubes.

Safety Information

- Upon receipt, inspect the product to verify that it has not been damaged during transport. If the product appears damaged, DO NOT INSTALL it and immediately report the damage to the carrier or retailer (if the installer or the authorized technician has collected the material from the retailer.)
- After completing the installation, always carry out a functional test and provide the instructions on how to operate the air conditioner to the user.
- Do not use the air conditioner in environments with hazardous substances or close to equipment that release free flames to avoid the occurrence of fires, explosions or injuries.
- Do not install the product in a place where thermohygrostat is needed (such as server room, machinery room, computer room, etc.) Those places do not provide guaranteed operation condition of the product therefore performance can be poor in these places.
- Do not install the product in a ship or a vehicle (such as a campervan). Salt, vibration or other environmental factor may cause the product malfunction, electric shock or fire.
- Excessive indoor humidity or clogged condensate drain lines may cause water to drip from indoor units. Do not install the indoor unit where dripping could result in damage to property, such as above electronic equipment or other sensitive instruments.
- Our units should be installed in compliance with the spaces shown in the installation manual, to ensure accessibility from both sides and allow repairs or maintenance operations to be carried out. The unit's components should be accessible and easy to disassemble without endangering people and objects. For this reason, when provisions of the installation manual are not complied with, the cost required to access and repair the units (in SAFETY CONDITIONS, as set out in prevailing regulations) with harnesses, ladders, scaffolding or any other elevation system will NOT be considered part of the warranty and will be charged to the end customer.
- Verify that the voltage and frequency of the power supply comply with the specifications and that the installed power is sufficient to ensure the operation of any other domestic appliance connected to the same electric lines.
- Always verify that the cut-off and protection switches are suitably dimensioned.
- Verify that the air conditioner is connected to the power supply in accordance with the instructions provided in the wiring diagram included in the manual.
- Always verify that electric connections (cable entry, section of leads, protections...) are compliant with the electric specifications and with the instructions provided in the wiring scheme. Always verify that all connections comply with the standards applicable to the installation of air conditioners.
- Devices disconnected from the power supply should be completely disconnected in the condition of overvoltage category.
- Be sure not to perform power cable modification, extension wiring, and multiple wire connection.
 - It may cause electric shock or fire due to poor connection, poor insulation, or current limit override.
 - When extension wiring is required due to power line damage, refer to "**Step 13 Optional: Extending the power cable**" in the installation manual.

CAUTION

Make sure that you earth the cables.

- Do not connect the earth wire to the gas pipe, water pipe, lighting rod or telephone wire. If earthing is not complete, electric shock or fire may occur.

Install the circuit breaker.

- If the circuit breaker is not installed, electric shock or fire may occur.

Make sure that the condensed water dripping from the drain hose runs out properly and safely.

Install the power cable and communication cable of the indoor and outdoor unit at least 1m away from the electric appliance.

Install the indoor unit away from lighting apparatus using the ballast.

- If you use the wireless remote control, reception error may occur due to the ballast of the lighting apparatus.

Do not use the indoor unit for preservation of food items, plants, equipment, and art works. This may cause deterioration of their quality.

Do not install the indoor unit if it has any drainage problem.

Power supply line, fuse or circuit breaker



WARNING

- Always make sure that the power supply is compliant with current safety standards. Always install the air conditioner in compliance with current local safety standards.
- Always verify that a suitable grounding connection is available.

Installation Procedure

Step 1 Checking and preparing accessories

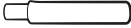
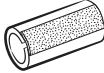
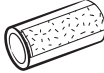
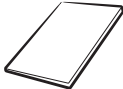
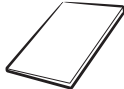
The following accessories are supplied with the indoor unit. The type and quantity may differ, depending on the specifications.

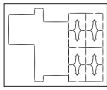
Pattern sheet A (1) Pattern sheet B (1)	Drain hose (1)
	
Insulation pipe (Liquid side1, gas side1)	Insulation drain hose (1)
	
Installation manual (1)	User manual (1)
	
Cable-tie (6)	Clamp (1)
	
Installation gauge (1)	
	

Step 2 Choosing the installation location

Installation location requirements

- There must be no obstacles near the air inlet and outlet.
- Install the indoor unit to a ceiling that can support its weight.
- Maintain sufficient clearance around the indoor unit.
- Before installing the indoor unit, be sure to check whether the chosen location has proper drainage possibilities.
- The indoor unit must be installed such that it is beyond public access and is not touchable by users.
- A vibration-resistant location that is not inclined (If the indoor unit is installed on a structure that is not sturdy, it may fall and get damaged or cause injury.)
- Where it is not exposed to direct sunshine.
- Where the air filter can be removed and cleaned easily.
- A location where animals cannot access and urinate on the product. Ammonia may be generated.

Installation Procedure

WARNING

- Because your air conditioner contains R-32 refrigerant, make sure that it is installed, operated, and stored in a room whose floor area is larger than the minimum required floor area specified in the following table:

m (kg)	Ceiling-mounted type (A, m ²)
≤1.842	No requirement
1.843	3.64
1.9	3.75
2.0	3.95
2.2	4.34
2.4	4.74
2.6	5.13
2.8	5.53
3.0	5.92
3.2	6.48
3.4	7.32
3.6	8.20
3.8	9.14
4.0	10.1
4.2	11.2
4.4	12.3
4.6	13.4
4.8	14.6
5.0	15.8
5.2	17.1
5.4	18.6
5.6	20.0
5.8	21.5
6.0	23.0

- m : Total refrigerant charge in the system
- A : Minimum required floor area

- IMPORTANT: it's mandatory to consider either the table above or taking into consideration the local law regarding the minimum living space of the premises.
- Minimum installation height of indoor unit is 0.6 m for floor mounted, 1.8 m for wall, 2.2 m for ceiling.

CAUTION

- As a rule, the unit cannot be installed at a height of less than 2.5m.
- If you install a cassette type indoor unit on the ceiling when temperature is over 27°C and humidity is over 80%, you must apply an extra 10mm thick polyethylene insulation or a similar type of insulation to the body of the indoor unit.

Do not install the air conditioner in following places.

- Place where there is mineral oil or arsenic acid. Resin parts flame and the accessories may drop or water may leak. The capacity of the heat exchanger may reduce or the air conditioner may be out of order.
- A place with exposure to mineral oil, oil vapour or cooking area where there is spray (If oil adheres to the heat exchanger, performance degradation, spray or condensation scattering may occur. If oil adheres to a plastic component, the component may deform or get damaged. Such issues may result in a system failure or refrigerant leak.)
- A place with aromatic diffusers, aromatherapy, scented candles or perfumes as the chemicals may react to the product's materials and may result in system failure or refrigerant leaks.
- The place where corrosive gas such as sulphuric acid gas generates from the vent pipe or air outlet.
- The copper pipe or connection pipe may corrode and refrigerant may leak.
- The place where there is a machine that generates electromagnetic waves. The air conditioner may not operate normally due to control system.
- The place where there is a danger of existing combustible gas, carbon fibre or flammable dust.
- The place where thinner or gasoline is handled. Gas may leak and it may cause fire.
- The place where is close to heat sources.
- Do not use the indoor unit for preservation of food items, plants, equipment, and art works. This may cause deterioration of their quality.
- Do not install the indoor unit if it has any drainage problem.

Indoor unit dimensions

4 way Cassette

(Unit: mm)

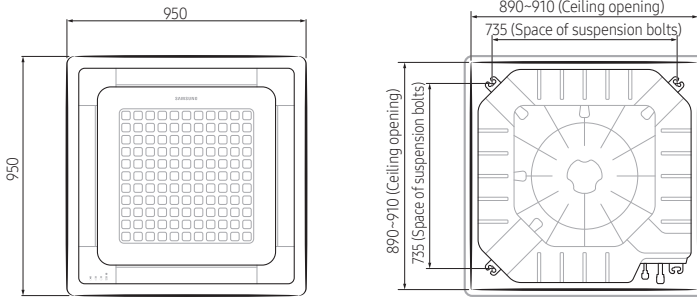

The appearance of the panel may be different from the picture depending on the model.

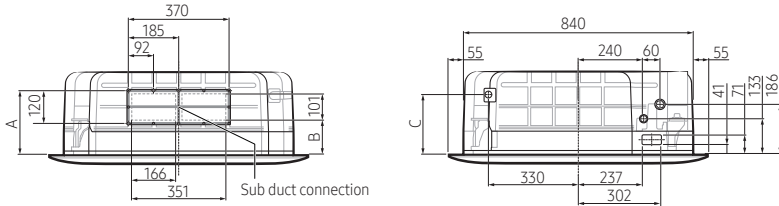

The sub duct hole is not applicable to the WindFree models.

Model		AC052BN4PKG	AC071BN4PKG	AC100BN4PKG	AC120BN4PKG	AC140BN4PKG
Chassis		Small	Large			
A	mm	215	238			
B	mm	105	127			
C	mm	196	222			
Net dimension (W x D x H)	mm	840 x 840 x 204		840 x 840 x 288		
Liquid pipe connection	mm	6.35	9.52			
Gas pipe connection	mm	9.52	15.88			
Drain hose connection	mm	VP25 (OD32, ID26.5)				

Installation Procedure

Spacing requirements

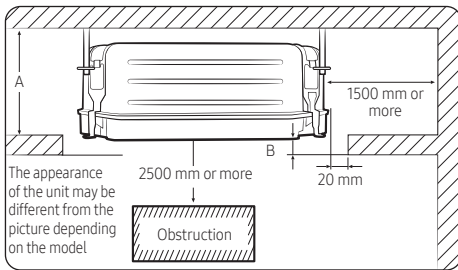

(Unit: mm)

Model	AC052BN4PKG	AC071BN4PKG	AC100BN4PKG	AC120BN4PKG	AC140BN4PKG
A	251			335	
B	17			17	

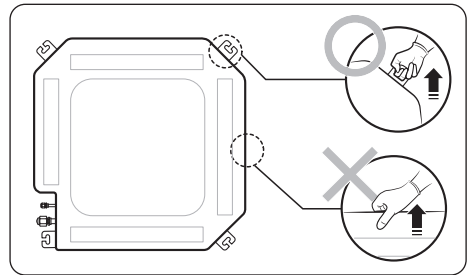
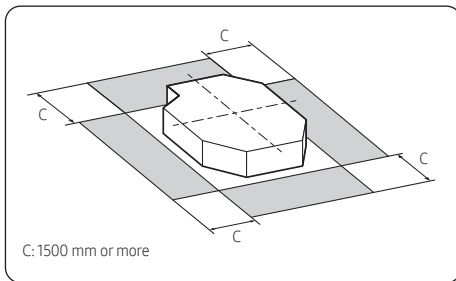

Step 3 Optional: Insulating the body of the indoor unit

If you install a cassette type indoor unit on the ceiling when temperature is over 27°C and humidity is over 80%, you must apply an extra 10 mm thick polyethylene insulation or a similar type of insulation to the body of the indoor unit.

Cut away the part where pipes are pulled out for the insulating work.

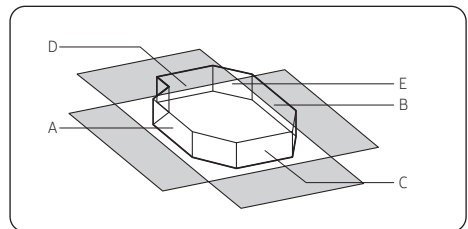

Insulate the end of the pipe and some curved area by using separate insulator.

NOTE

- A: Reference for the outer circumference of the unit (When insulating the body of the indoor unit, use A as the reference for its outer circumference.)

(Unit: mm)

Chassis	Model	A	B	C	D	E
Small (840 x 204 x 840)	AC052BN4PKG	910 x 151	940 x 151	610 x 151	650 x 151	870 x 870
	AC071BN4PKG					
Large (840 x 288 x 840)	AC100BN4PKG	910 x 235	940 x 235	610 x 235	650 x 235	870 x 870
	AC120BN4PKG					
	AC140BN4PKG					

CAUTION

- Comply with the length and height limits described in the figure above.
- For the product that uses the R-32 refrigerant, install the indoor unit on the wall 1.8 m or higher from the floor.
- The indoor unit must be installed according to the specified distances in order to permit accessibility from each side, to guarantee correct operation, maintenance, and repair of the unit. The components of the indoor unit must be reachable and removable under safe conditions for people and the unit.
- Do not carry the unit by holding the refrigerant or drain pipes to avoid product damage.
- Carry the unit by holding the hanger plates located on the corners of the unit.

Step 4 Installing the indoor unit

When deciding on the location of the air conditioner the following restrictions must be taken into account.

- 1 Place the pattern sheet on the ceiling at the spot where you want to install the indoor unit.

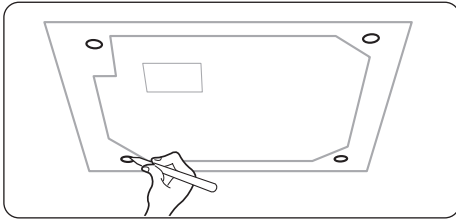

NOTE

- Since the diagram is made of paper, it may shrink or stretch slightly due to temperature or humidity. For this reason, before drilling the holes, be sure to maintain the correct dimensions between the markings.
- 2 Insert bolt anchors, use existing ceiling supports or construct a suitable support as shown in figure.

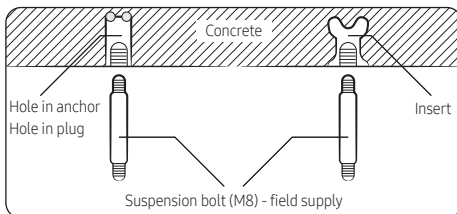

- 3 Install the suspension bolts, depending on the ceiling type.

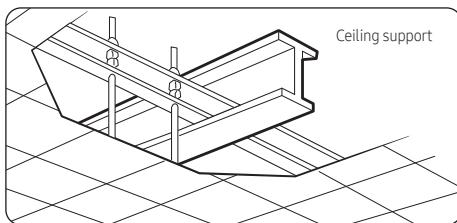

CAUTION

- Make sure that the ceiling is strong enough to support the weight of the indoor unit. Before hanging the unit, test the strength of each attached suspension bolt.
 - If the length of the suspension bolt is more than 1.5 m, you are required to prevent vibration.
- 4 Screw eight pairs of nuts and washers to the suspension bolts, making space for hanging the indoor unit.

CAUTION

- You must install all of the suspension rods.
 - It is important to leave sufficient space in the false ceiling to allow access for maintenance or repairs to the drainage pipe connection, the refrigerant pipe connection, or to remove the unit if necessary.
- 5 Hang the indoor unit to the suspension bolts between two nuts. Cut a pad stopper and place it on the suspension bolts to hold the washers. Remove the stopper and screw the nuts to fix the unit.

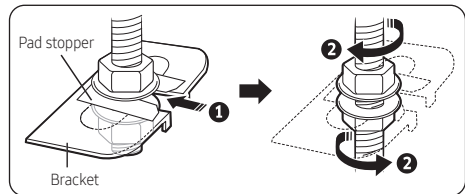

- 6 Check the level of the indoor unit by using a level.
 - A tilt of the indoor unit may cause malfunction of a built-in float switch and water leaks.

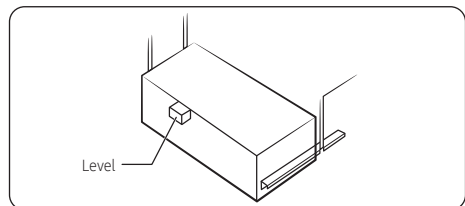

Installation Procedure

- Adjust the unit to the appropriate position, taking into account the installation area for the front panel.
 - Place the pattern sheet on the indoor unit.
 - Adjust the space between the ceiling and the indoor unit by using a dimension gauge.
 - Fix the indoor unit securely after adjusting the level of the unit by using a leveller.
 - Remove the pattern sheet, connect the other cables, and install the front panel.

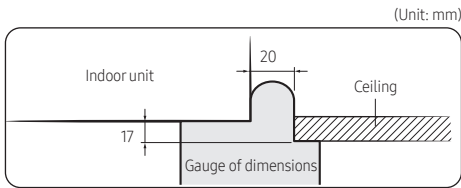

Step 5 Purging inert gas from the indoor unit

The indoor unit comes with nitrogen gas (inert gas) charged at the factory. Therefore, all inert gas must be purged before connecting the assembly piping.

Unscrew the pinch pipe at the end of each refrigerant pipe.

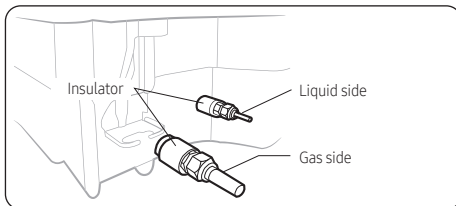

NOTE

- To prevent dirt or foreign objects from getting into the pipes during installation, do not remove the pinch pipe completely until you are ready to connect the piping.

Step 6 Cutting and flaring the pipes

- Make sure that you have the required tools available: pipe cutter, reamer, flaring tool, and pipe holder.
- If you wish to shorten the pipes, cut them with a pipe cutter, ensuring that the cut edge remains at a 90° angle to the side of the pipe. Refer to the illustrations below for examples of edges cut correctly and incorrectly.

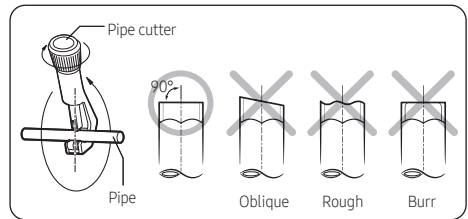

- To prevent any gas from leaking out, remove all burrs at the cut edge of the pipe, using a reamer.
- Slide a flare nut on to the pipe and modify the flare.

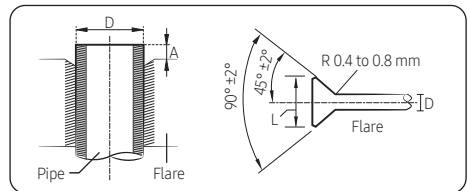

Outer Diameter (D)	Depth (A)	Flare dimension (L)
Ø6.35 mm	1.3 mm	8.7 to 9.1 mm
Ø9.52 mm	1.8 mm	12.8 to 13.2 mm
Ø12.70 mm	2.0 mm	16.2 to 16.6 mm
Ø15.88 mm	2.2 mm	19.3 to 19.7 mm
Ø19.05 mm	2.2 mm	23.6 to 24.0 mm

- Check that the flaring is correct, referring to the illustrations below for examples of incorrect flaring.

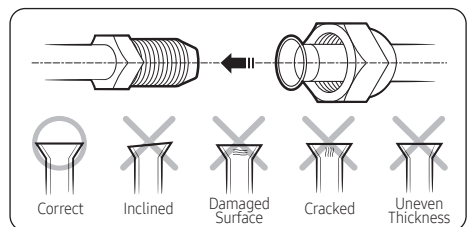

Step 7 Connecting the assembly pipes to the refrigerant pipes

There are two refrigerant pipes of different diameters :

- A smaller one for the liquid refrigerant.
 - A larger one for the gas refrigerant. The inside of copper pipe must be clean and has no dust.
- 1 Remove the pinch pipe on the pipes and connect the assembly pipes to each pipe, tightening the nuts, first manually and then with a torque wrench, a spanner applying the following torque.

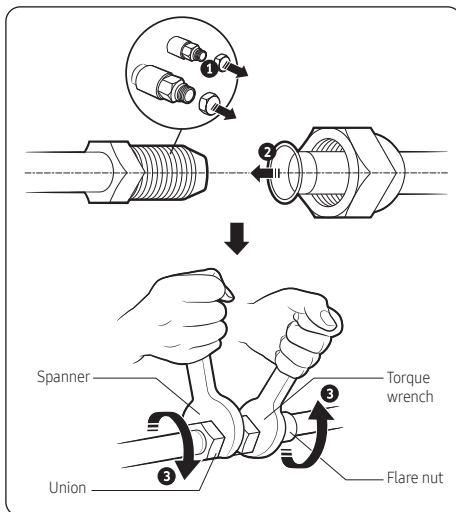

Outer Diameter (mm)	Torque (N•m)
Ø6.35	14 to 18
Ø9.52	34 to 42
Ø12.70	49 to 61
Ø15.88	68 to 82
Ø19.05	100 to 120

(1 N•m=10 kgf•cm)

NOTE

- If the pipes must be shortened, see **Step 6 Cutting and flaring the pipes**.
- 2 Be sure to use an insulator thick enough to cover the refrigerant tube to protect the condensate water on the outside of the pipe falling onto the floor and to improve the efficiency of the unit.

- 3 Cut off any excess foam insulation.
- 4 Make sure that there are no cracks or waves on the bent area.
- 5 It would be necessary to double the insulation thickness (10 mm or more) to prevent condensation even on the insulator when if the installed area is warm and humid.
- 6 Do not use joints or extensions for the pipes connecting the indoor and outdoor units. The only permitted connections are those for which the units are designed.

CAUTION

- Connect the indoor and outdoor units using pipes with flared connections (not supplied). For the lines, use insulated, unwelded, degreased and deoxidized copper pipe (Cu DHP type to ISO 1337 or UNI EN 12735-1), suitable for operating pressures of at least 4.2 MPa and for a burst pressure of at least 20.7 MPa. Copper pipe for hydro-sanitary applications is completely unsuitable.
- For sizing and limits (height difference, line length, max. bends, refrigerant charge, etc.) see the outdoor unit installation manual.
- All refrigerant connection must be accessible, in order to permit either unit maintenance or removing it completely.
- If the pipes require brazing, make sure that oxygen free nitrogen (OFN) is flowing through the system.
- Nitrogen blowing pressure range is 0.02 to 0.05 MPa.

Step 8 Performing the gas leak test

To identify potential gas leaks on the indoor unit, inspect the connection area of each refrigerant pipe using a leak detector for R-32.

Before recreating the vacuum and recirculating the refrigerant gas, pressurize the whole system with nitrogen (using a cylinder with a pressure reducer) at a pressure above 4 MPa in order to immediately detect leaks on the refrigerant fittings.

Made vacuum for 15 minutes and pressurizing system with nitrogen.

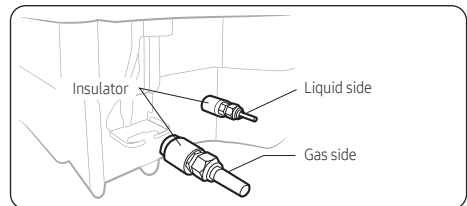

Installation Procedure

Step 9 Insulating the refrigerant pipes

Once you have checked that there are no leaks in the system, you can insulate the piping and hose.

- 1 To avoid condensation problems, place Acrylonitrile Butadiene Rubber separately around each refrigerant pipe.

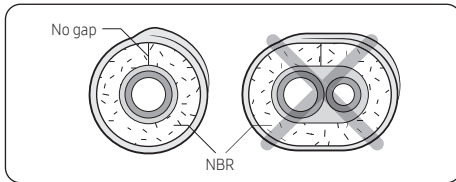

NOTE

- Always make the seam of pipes face upwards.
- 2 Wind insulating tape around the pipes and drain hose avoiding compressing the insulation too much.

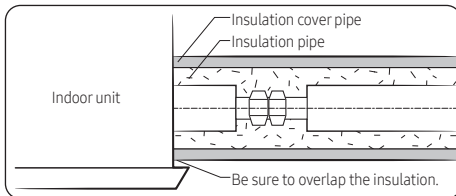

CAUTION

- Be sure to wrap insulation tightly without any gaps.
- 3 Finish wrapping insulating tape around the rest of the pipes leading to the outdoor unit.
 - 4 The pipes and electrical cables connecting the indoor unit with the outdoor unit must be fixed to the wall with suitable ducts.

CAUTION

- Make sure that all refrigerant connection must be accessible for easy maintenance and detachment.
- Install the insulation not to get wider and use the adhesives on the connection part of it to prevent moisture from entering.
- Wind the refrigerant pipe with insulation tape if it is exposed to outside sunlight.
- Install the refrigerant pipe respecting that the insulation does not get thinner on the bent part or hanger of pipe.

- Add the additional insulation if the insulation plate gets thinner.

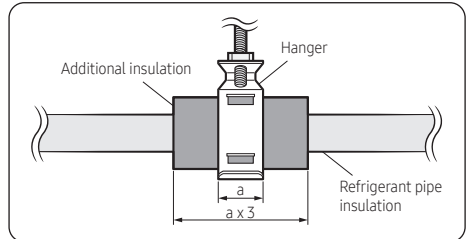

- 5 Select the insulation of the refrigerant pipe.
 - Insulate the gas side and liquid side pipe, noting the insulation thickness that must differ according to the pipe size.
 - Standard: Less than an indoor temperature of 30°C, with humidity at 85%. If installing in a high humidity environment, use one grade thicker insulator by referring to the table below. If installing in an unfavourable environment, use thicker one.
 - The heat-resistance temperature of the insulator must be more than 120°C.

CAUTION

- Must fit tightly against body without any gap.
- All refrigerant connection must be accessible, in order to permit either unit maintenance or removal.

Pipe	Pipe size (mm)	Insulation type (heating/cooling)		Remarks
		Standard (Less than 30°C, 85%)	High humidity (Over 30°C, 85%)	
		EPDM, NBR (mm)		
Liquid pipe	Ø6.35 to Ø9.52	9t	9t	The internal temperature is higher than 120°C.
	Ø12.7 to Ø19.05	13t	13t	
Gas pipe	Ø6.35	13t	19t	
	Ø9.52	19t	25t	
	Ø12.70			
	Ø15.88			
Ø19.05				

- When installing insulation in the places and conditions below, use the same insulation that is used for high humidity conditions.

<Geological condition>

High humidity locations such as shorelines, hot springs, lake or riversides, and ridges (when part of the building is covered by earth and sand)

<Operation purpose condition>

Restaurant ceiling, sauna, swimming pool etc.

<Building construction condition>

Ceilings frequently exposed to moisture and cooling are not covered. For example, pipes installed at a corridor of a dormitory and studio or near an exit that opens and closes frequently.

Places (where the pipes are installed) that are highly humid due to a lack of ventilation.

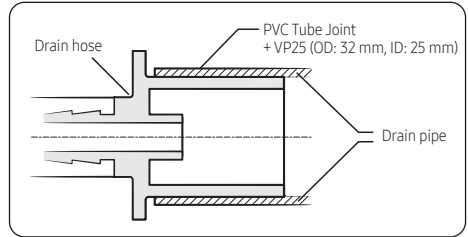

⚠ CAUTION

Check that the indoor unit is level with the ceiling by using the leveller.

- Install air ventilation to drain condensation smoothly.

Step 10 Installing the drain hose and drain pipe

- Push the supplied drain hose as far as possible over the drain socket.
- Tighten the metal clamp as shown in the picture.

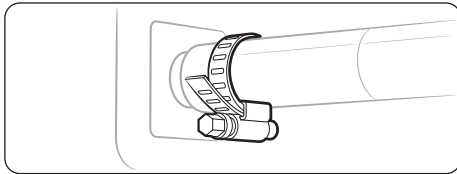

- Wrap the supplied drain insulation over the metal clamp and drain hose to insulate and fix it with clamps.
- Insulate the complete drain piping inside the building (field supply).
If the drain hose cannot be sufficiently set on a slope, fit the hose with drain raising piping (field supply).
- Push the drain hose up to insulation when connecting the drain hose to drain socket.

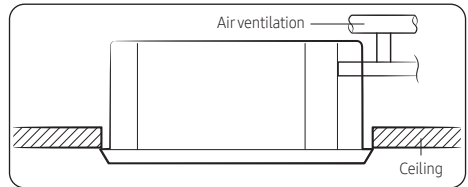
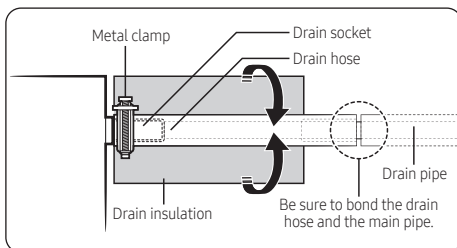

- If it is necessary to increase the height of the drain pipe, install the drain pipe straight within 300 mm from the drain hose port. If it is raised higher than 550 mm, there may be water leaks.

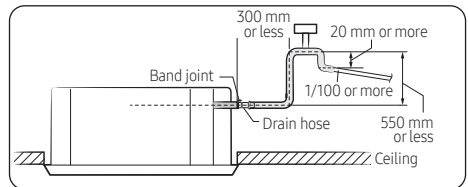

- Do not give the hose an upward gradient beyond the connection port. This will cause water to flow backwards when the unit is stopped, resulting in water leaks.

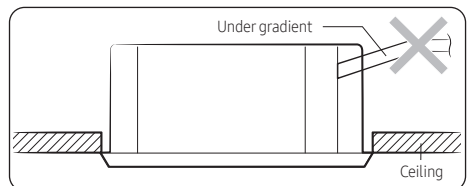

Installation Procedure

- Do not apply force to the piping on the unit side when connecting the drain hose. The hose should not be allowed to hang loose from its connection to the unit. Fasten the hose to a wall, frame or other support as close to the unit as possible.

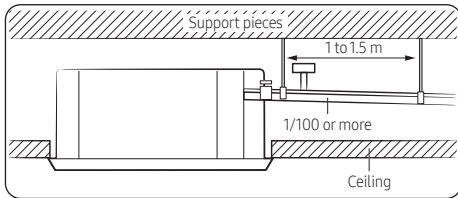

- Install horizontally.

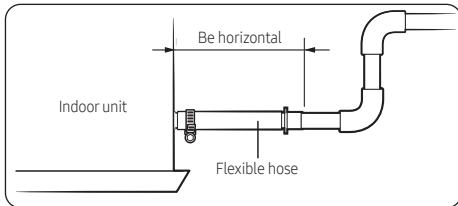

- Max. allowable axis gap.

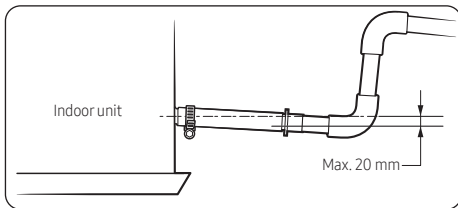

- Max. allowable bending angle.

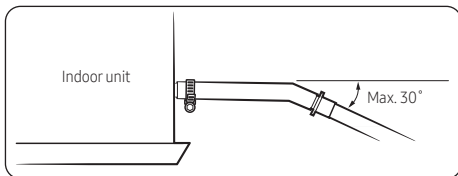

NOTE

- If a concentrated drain pipe is installed, refer to the figure below.

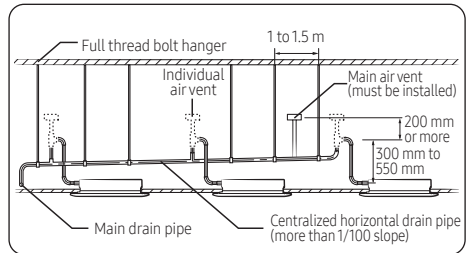

- If 3 or more units are installed, install a main air vent in front of the farthest indoor unit from the main drain pipe.
- To prevent water from flowing back to indoor units, install an individual air vent at the top of each indoor unit.
 - The air vents should be T or 7 shaped to prevent dust or foreign substances from entering.
 - You may not need to install an air vent if the horizontal drain pipe has a proper slope.

Step 11 Performing the drainage test

- Do a leak test at the connection part of the flexible hose and the drain pipe:
 - Connect a general hose to the connection part of the flexible hose of the indoor unit, and pour in some water.

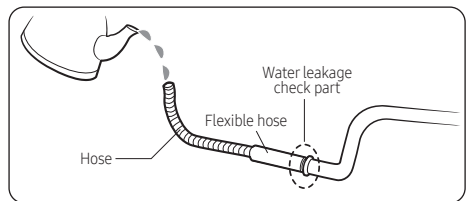

- After pouring some water, reassemble the rubber cap on the connection part of a flexible hose of the indoor unit and firmly tighten it with a band to prevent leakage.
- Check the leak test at the part where the adhesive for the flexible hose and the drain pipe is used.

CAUTION

- The leak test must be performed for at least 24 hours.

- 2 Check the condensed water drainage:
 - a Pour about 2 liters of water into the indoor unit drain pan as shown in the picture.

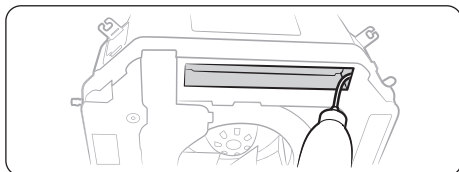

- b When the electric cable connection is completed
 - Turn on the indoor unit and outdoor unit.
 - Operate in the Cool mode.

CAUTION

- Only in the Cool mode, you can check the correct operation of the drain pump.

When the electric cable connection has not been completed

- Remove the control box cover of the indoor unit.
- Connect the power supply (220~240V, 50 Hz) to the L and N terminals.
- Reassemble the control box cover and turn on the indoor unit.

CAUTION

- When the float switch is not detected due to insufficient water on the drain pan, the drain pump will not work.
- If the power supply is directly connected to the L and N terminals, communication error message might appear.
- After completing the drainage check, turn the unit off and disconnect the power supply.
- Reassemble the control box cover.

- c Check whether the drain pump works correctly.
- d Check whether the drainage is performing correctly at the end of the drain pipe.
- e Check for leakage at the drain pipe and drain pipe connection part.

- f When leakage occurs, check whether the indoor unit is level and check the drain hose connection part, drainpipe connection part and drain pump connection.
- g When the drainage check is completed and the condensed water remains on the drain pan, remove the water.

Step 12 Connecting the power and communication cables

CAUTION

- Always remember to connect the refrigerant pipes before performing the electric connections. When disconnecting the system, always disconnect the electric cables before disconnecting the refrigerant pipes.
- For the product that uses the R-32 refrigerant, be cautious not to generate a spark by keeping the following requirements:
 - Do not remove the fuses with power on.
 - Do not disconnect the power plug from the wall outlet with power on.
 - It is recommended to locate the outlet in a high position. Place the cords so that they are not tangled.
- Always remember to connect the air conditioner to the grounding system before performing the electric connections. Use a crimp ring terminal at the end of each wire.

The indoor unit is powered through the outdoor unit by means of a H07 RN-F connection cable (or a more power model), with insulation in synthetic rubber and a jacket in polychloroprene (neoprene), in accordance with the requirements specified in the standard EN 60335-2-40.

- 1 Remove the screw on the electrical component box and remove the cover plate.
- 2 Route the connection cord through the side of the indoor unit and connect the cable to the terminals refer to the figure below.
- 3 Route the other end of the cable to the outdoor unit through the ceiling & the hole on the wall.
- 4 Reassemble the electrical component box cover, carefully tightening the screw.

Installation Procedure

1 phase

(Unit: mm)

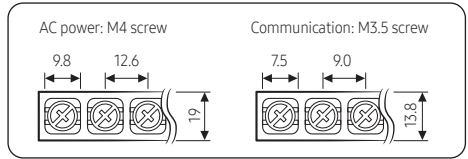
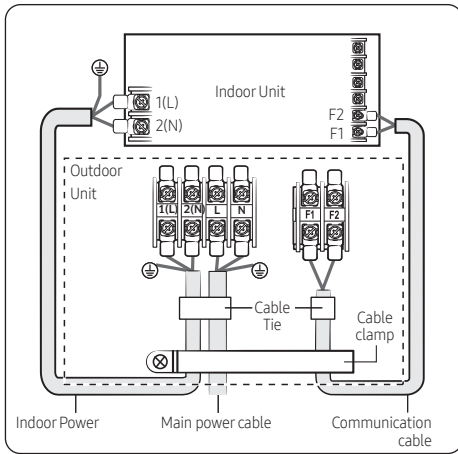

Tightening torque (kgf • cm)	
M3.5	8.0 to 12.0
M4	12.0 to 18.0

1 N•m = 10 kgf•cm

- Power supply cords of parts of appliances for outdoor use shall not be lighter than polychloroprene sheathed flexible cord. (Code designation IEC:60245 IEC 57 / CENELEC: H05RN-F or IEC:60245 IEC 66 / CENELEC: H07RN-F)
- Since it has the external power supply, refer to the outdoor unit installation manual for MAIN POWER.

3 phase

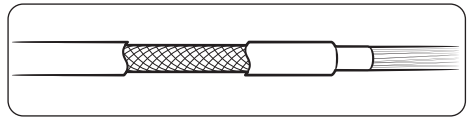
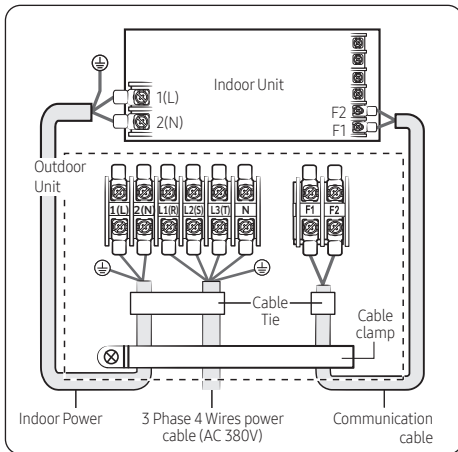

⚠ CAUTION

- When installing the indoor unit in a computer room or network room, use the double shielded communication cable (tape aluminum / polyester braid + copper) of FROHH2R or LiYCY type.

Step 13 Optional: Extending the power cable

- Prepare the following tools.

Indoor power supply		
Power supply	Max/Min(V)	Indoor power cable
220 to 240V, 50 Hz	±10%	0.75 mm ² t, 3 wires
Communication cable		
0.75 mm ² , 2 wires		

Tools	Spec	Shape
Crimping pliers	MH-14	
Connection sleeve (mm)	20xØ6.5 (HxØD)	
Insulation tape	Width 19 mm	
Contraction tube (mm)	70xØ8.0 (LxØD)	

- 2 As shown in the figure, peel off the shields from the rubber and wire of the power cable.
- Peel off 20 mm of cable shields from the pre-installed tube.

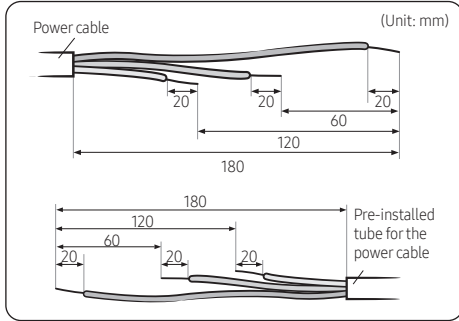

CAUTION

- For information about the power cable specifications for indoor and outdoor units, refer to the installation manual.
 - After peeling off cable wires from the pre-installed tube, insert a contraction tube.
- 3 Insert both sides of core wire of the power cable into the connection sleeve.
- **Method 1:** Push the core wire into the sleeve from both sides.
 - **Method 2:** Twist the wire cores together and push it into the sleeve.

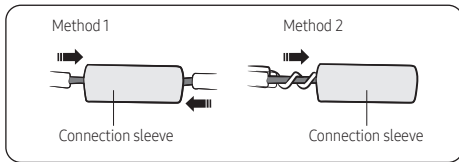

CAUTION

- If cable wires are connected without using connecting sleeves, their contact area becomes reduced, or corrosion develops on the outer surfaces of the wires (copper wires) over a long time. This may cause an increase of resistance (reduction of passing current) and consequently may result in a fire.

- 4 Using a crimping tool, compress the two points and flip it over and compress another two points in the same location.
- The compression dimension should be 8.0.

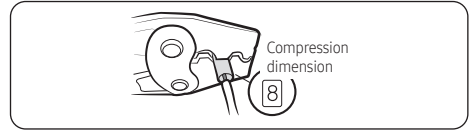

- After compressing it, pull both sides of the wire to make sure it is firmly pressed.

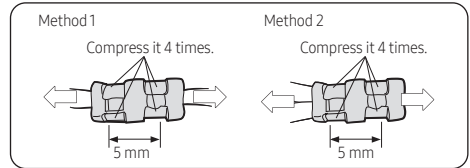

- 5 Apply heat to the contraction tube to contract it.

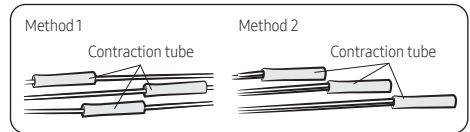

- 6 Wrap it with the insulation tape twice or more and position your contraction tube in the middle of the insulation tape.

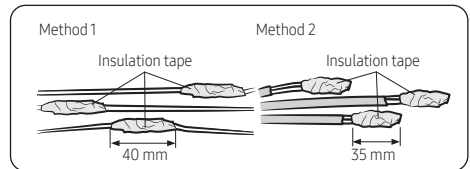

- 7 After tube contraction work is completed, wrap it with the insulation tape to finish. Three or more layers of insulation are required.

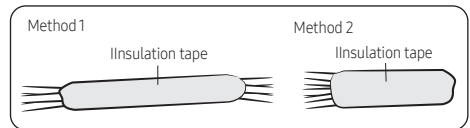

Installation Procedure

⚠ CAUTION

- Make sure that the connection parts are not exposed to outside.
- Be sure to use insulation tape and a contraction tube made of approved reinforced insulating materials that have the same level of withstand voltage with the power cable. (Comply with the local regulations on extensions.)

⚠ WARNING

- In case of extending the electric wire, please DO NOT use a round-shaped Pressing socket.
 - Incomplete wire connections can cause electric shock or a fire.

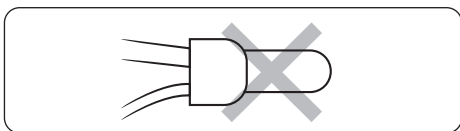

Step 14 Setting the indoor unit addresses and the installation options

You cannot set both of the indoor unit addresses and the installation options in a batch: set both of them respectively.

Common steps for setting the addresses and options

Remote controls

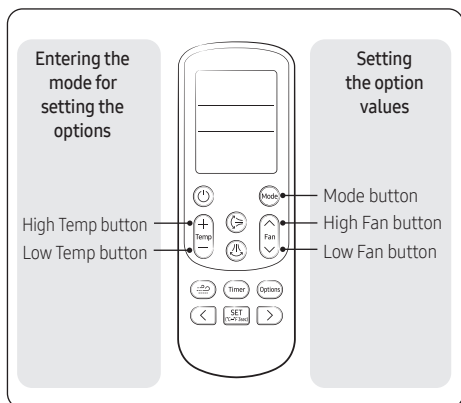

📖 NOTE

- The remote control display and buttons may vary depending on the model.
- 1 Enter the mode for setting the options:
 - a Remove the batteries from the remote control, and then insert them again.
 - b While holding down the (High Temp) and (Low Temp) buttons simultaneously, insert the batteries into the remote control.
 - c Make sure that you are entered to the mode for setting the options:

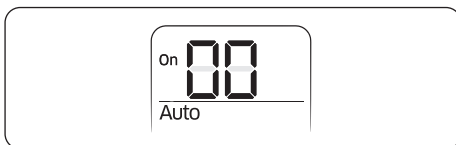

- 2 Set the option values.





















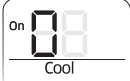
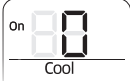

⚠ WARNING

- The total number of available options are 24: SEG1 to SEG24.
- Because SEG1, SEG7, SEG13, and SEG19 are the page options used by the previous remote control models, the modes to set values for these options are skipped automatically.
- Set a 2-digit value for each option pair in the following order: SEG2 and SEG3 → SEG4 and SEG5 → SEG6 and SEG8 → SEG9 and SEG10 → SEG11 and SEG12 → SEG14 and SEG15 → SEG16 and SEG17 → SEG18 and SEG20 → SEG21 and SEG22 → SEG23 and SEG24















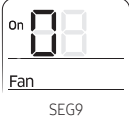

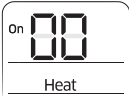

SEG1	SEG2	SEG3	SEG4	SEG5	SEG6
0	X	X	X	X	X
SEG7	SEG8	SEG9	SEG10	SEG11	SEG12
1	X	X	X	X	X
SEG13	SEG14	SEG15	SEG16	SEG17	SEG18
2	X	X	X	X	X
SEG19	SEG20	SEG21	SEG22	SEG23	SEG24
3	X	X	X	X	X

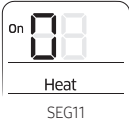
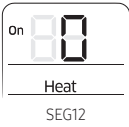





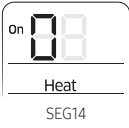
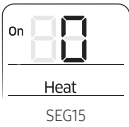







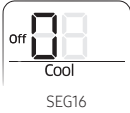
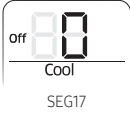

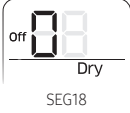
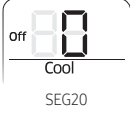

On (SEG1 to SEG12)	Off (SEG13 to SEG24)

Take the steps presented in the following table:



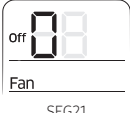

Steps	Remote control display
<p>1 Set the SEG2 and SEG3 values:</p> <p>a Set the SEG2 value by pressing the  (Low Fan) button repeatedly until the value you want to set appears on the remote control display.</p> <p>b Set the SEG3 value by pressing the  (High Fan) button repeatedly until the value you want to set appears on the remote control display.</p> <p>When you press the  (Low Fan) or  (High Fan) button, values appear in the following order: 0 → 1 → ... E → F</p>	 <p style="text-align: center;">SEG2</p>  <p style="text-align: center;">SEG3</p>
<p>2 Press the  (Mode) button. Cool and On appear on the remote control display.</p>	
<p>3 Set the SEG4 and SEG5 values:</p> <p>a Set the SEG4 value by pressing the  (Low Fan) button repeatedly until the value you want to set appears on the remote control display.</p> <p>b Set the SEG5 value by pressing the  (High Fan) button repeatedly until the value you want to set appears on the remote control display.</p> <p>When you press the  (Low Fan) or  (High Fan) button, values appear in the following order: 0 → 1 → ... E → F</p>	 <p style="text-align: center;">SEG4</p>  <p style="text-align: center;">SEG5</p>
<p>4 Press the  (Mode) button. Dry and On appear on the remote control display.</p>	
<p>5 Set the SEG6 and SEG8 values:</p> <p>a Set the SEG6 value by pressing the  (Low Fan) button repeatedly until the value you want to set appears on the remote control display.</p> <p>b Set the SEG8 value by pressing the  (High Fan) button repeatedly until the value you want to set appears on the remote control display.</p> <p>When you press the  (Low Fan) or  (High Fan) button, values appear in the following order: 0 → 1 → ... E → F</p>	 <p style="text-align: center;">SEG6</p>  <p style="text-align: center;">SEG8</p>
<p>6 Press the  (Mode) button. Fan and On appear on the remote control display.</p>	

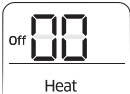
Installation Procedure

Steps	Remote control display
<p>7 Set the SEG9 and SEG10 values:</p> <p>a Set the SEG9 value by pressing the  (Low Fan) button repeatedly until the value you want to set appears on the remote control display.</p> <p>b Set the SEG10 value by pressing the  (High Fan) button repeatedly until the value you want to set appears on the remote control display.</p> <p>When you press the  (Low Fan) or  (High Fan) button, values appear in the following order: 0 → 1 → ... → E → F</p>	 
<p>8 Press the  (Mode) button. Heat and On appear on the remote control display.</p>	
<p>9 Set the SEG11 and SEG12 values:</p> <p>a Set the SEG11 value by pressing the  (Low Fan) button repeatedly until the value you want to set appears on the remote control display.</p> <p>b Set the SEG12 value by pressing the  (High Fan) button repeatedly until the value you want to set appears on the remote control display.</p> <p>When you press the  (Low Fan) or  (High Fan) button, values appear in the following order: 0 → 1 → ... → E → F</p>	 
<p>10 Press the  (Mode) button. Auto and Off appear on the remote control display.</p>	
<p>11 Set the SEG14 and SEG15 values:</p> <p>a Set the SEG14 value by pressing the  (Low Fan) button repeatedly until the value you want to set appears on the remote control display.</p> <p>b Set the SEG15 value by pressing the  (High Fan) button repeatedly until the value you want to set appears on the remote control display.</p> <p>When you press the  (Low Fan) or  (High Fan) button, values appear in the following order: 0 → 1 → ... → E → F</p>	 
<p>12 Press the  (Mode) button. Cool and Off appear on the remote control display.</p>	

Steps	Remote control display
<p>13 Set the SEG16 and SEG17 values:</p> <p>a Set the SEG16 value by pressing the  (Low Fan) button repeatedly until the value you want to set appears on the remote control display.</p> <p>b Set the SEG17 value by pressing the  (High Fan) button repeatedly until the value you want to set appears on the remote control display.</p> <p>When you press the  (Low Fan) or  (High Fan) button, values appear in the following order: 0 → 1 → ... E → F</p>	 
<p>14 Press the  (Mode) button. Dry and Off appear on the remote control display.</p>	
<p>15 Set the SEG18 and SEG20 values:</p> <p>a Set the SEG18 value by pressing the  (Low Fan) button repeatedly until the value you want to set appears on the remote control display.</p> <p>b Set the SEG20 value by pressing the  (High Fan) button repeatedly until the value you want to set appears on the remote control display.</p> <p>When you press the  (Low Fan) or  (High Fan) button, values appear in the following order: 0 → 1 → ... E → F</p>	 
<p>16 Press the  (Mode) button. Fan and Off appear on the remote control display.</p>	
<p>17 Set the SEG21 and SEG22 values:</p> <p>a Set the SEG21 value by pressing the  (Low Fan) button repeatedly until the value you want to set appears on the remote control display.</p> <p>b Set the SEG22 value by pressing the  (High Fan) button repeatedly until the value you want to set appears on the remote control display.</p> <p>When you press the  (Low Fan) or  (High Fan) button, values appear in the following order: 0 → 1 → ... E → F</p>	 
<p>18 Press the  (Mode) button. Heat and Off appear on the remote control display.</p>	

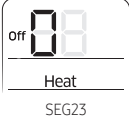
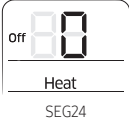

Installation Procedure

Steps	Remote control display
<p>19 Set the SEG23 and SEG24 values:</p> <p>a Set the SEG23 value by pressing the  (Low Fan) button repeatedly until the value you want to set appears on the remote control display.</p> <p>b Set the SEG24 value by pressing the  (High Fan) button repeatedly until the value you want to set appears on the remote control display.</p> <p>When you press the  (Low Fan) or  (High Fan) button, values appear in the following order: 0 → 1 → ... → E → F</p>	 

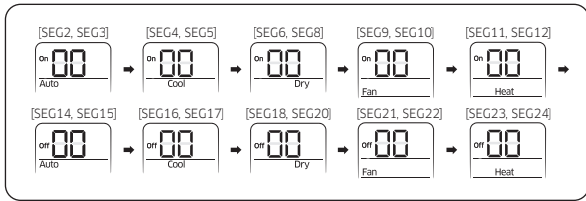

3 Check whether the option values that you have set are correct by pressing the  (Mode) button repeatedly



4 Save the option values into the indoor unit:

Point the remote control to the remote control sensor on the indoor unit and then press the  (Power) button on the remote control twice. Make sure that this command is received by the indoor unit. When it is successfully received, you can hear a short sound from the indoor unit. If the command is not received, press the  (Power) button again.

5 Check whether the air conditioner operates in accordance with the option values you have set:

- a** Reset the indoor or outdoor unit.
 - Indoor unit : Press the  (Set) and  (Low Fan) buttons on the remote control simultaneously for 4 seconds.
 - Outdoor unit : Press the K3 button.
- b** Remove the batteries from the remote control, insert them again, and then press the  (Power) button on the remote control.

Setting the indoor unit addresses

Option No. for an indoor unit address: 0AXXXX-1XXXXX-2XXXXX-3XXXXX

Before installing an indoor unit, be sure to set an address for the indoor unit by taking the following steps:

- 1 Make sure that the power is supplied to the indoor unit.
If the indoor unit is not plugged in, it must include a power supply.

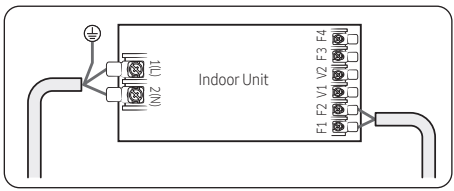

- 2 Set an address for each indoor unit using the remote control, according to your air conditioning system plan, by referring to the following table and by following the steps in **Common steps for setting the addresses and options** on page 18.
 - The indoor unit addresses (main and RMC addresses) are set to 0A0000-100000-200000-300000 by default.
 - If indoor units and outdoor units match 1:1, you don't need to set the main address because it is automatically set by the outdoor unit.
 - If you are using on or off controller, set RMC address.

Option	SEG1		SEG2		SEG3		SEG4	SEG5		SEG6	
Function	Page		Mode		Setting main address		Reserved	Indoor unit number		Indoor unit number	
Indication and details	Indication	Details	Indication	Details	Indication	Details		Indication	Details	Indication	Details
	0		A		0	No main address		0 to 1	Tens digit	0 to 9	Units digit
					1	Main address setting mode					
Option	SEG7		SEG8		SEG9		SEG10	SEG11		SEG12	
Function	Page		Reserved		Setting RMC address		Reserved	Group channel (x16)		Group address	
Indication and details	Indication	Details			Indication	Details		Indication	Details	Indication	Details
	1				0	No RMC address		RMC1	0 to 2	RMC2	0 to F
			1	RMC address setting mode							

CAUTION

- The main address must be set to a value in the range 0 to 15. If you set other values, communication error will occur.
- If any of SEG5 and SEG6 is set to a value in the range A to F, the main address of the indoor unit does not change.
- If SEG3 is set to 0, the indoor unit maintains the existing main address even if SEG6 is set to a new value.
- If SEG9 is set 0, the indoor unit maintains the existing RMC address even if SEG11 and SEG12 are set to new values.

Installation Procedure

Setting the installation options in a batch

Option No. for an indoor unit address: 02XXXX-1XXXXX-2XXXXX-3XXXXX

- 1 Make sure that the power is supplied to the indoor unit. If the indoor unit is not plugged in, it must include a power supply.

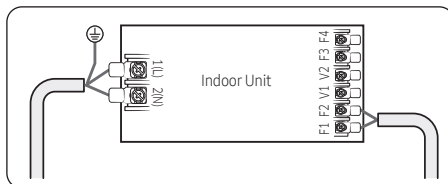

- 2 Set the installation options of indoor units, by referring to the following table and by following the steps in **Common steps for setting the addresses and options** on page 18.
 - The installation options of indoor units are set to 020010-100001-200000-300000 by default.
 - The SEG20 option, Individual control with remote control, allows you to control multiple indoor units individually by using the remote control.

Option	SEG1		SEG2		SEG3	SEG4		SEG5		SEG6			
Function	Page		Mode			Use of external room temperature sensor / Minimizing fan operation when thermostat is off ¹⁾		Use of central control		Compensation of the fan RPM			
Indication and details	Indication	Details	Indication	Details	Reserved	Indication	Details	Indication	Details	Indication	Details		
	0		2			0	Disuse	0	Disuse	0	Disuse		
	1					1	Use	Disuse					
	2					2	Disuse	Use (Heating)					
	3					3	Use	Use (Heating)					
	4					4	Disuse	Use (Cooling)					
	5					5	Use	Use (Cooling)					
	6					6	Disuse	Use (Cooling/Heating)	1	Use	1	Use	
	7					7	Use	Use (Cooling/Heating)					
	8					8	Disuse	Use (Cooling Ultra low speed)					
	9					9	Use	Use (Cooling Ultra low speed)					
	A					A	Disuse	Use (Heating/ Cooling Ultra low speed)					
B				B	Use	Use (Heating/ Cooling Ultra low speed)							
Option	SEG7		SEG8		SEG9	SEG10		SEG11		SEG12			
Function	Page		Use of drain pump ²⁾			Reserved		WindFree Fan RPM ³⁾		Dew removal operation in WindFree mode			
Indication and details	Indication	Details	Indication	Details	Reserved	Reserved		Indication	Details	Indication	Details		
	1		0	Disuse				0	Default	0	Maintain blade status in WindFree mode		
			1	Use				1	1 STEP ↓				
								2	2 STEP ↓				
								3	3 STEP ↓				
								4	4 STEP ↓				
			2	Use with 3-min delay				5	5 STEP ↓	1	(Default) Cooling operation by opening the blade		

Option	SEG13		SEG14			SEG15		SEG16	SEG17		SEG18		
Function	Page		Use of external control ⁴⁾			Setting the output of external control		Reserved	Buzzer control		Maximum filter usage time ⁵⁾		
Indication and details	Indication	Details	Indication	Details		Indication	Details		Indication	Details	Indication	Details	
	2			0	Disuse		0		Thermo On	0	Disuse	2	1000 hrs
				1	On/Off			Sub, Existing control					
				2	Off								
				3	Window On/Off			Main, Existing control					
				4	Disuse								
				5	On/Off								
				6	Off		Sub, Reverse control						
				7	Window On/Off								
				8	Disuse								
				9	On/Off		1	Operation On	1	Use	6	2000 hrs	
				A	Off								
				B	Window On/Off								
				C	Disuse								Main, Reverse control
				D	On/Off								
E				Off									
F	Window On/Off												

Option	SEG19		SEG20		SEG21		SEG22	SEG23			SEG24							
Function	Page		Individual control with remote control ⁴⁾		Heating setting compensation ⁷⁾		Reserved	Setting the MDS kit installation option ⁸⁾			Reserved							
Indication and details	Indication	Details	Indication	Details	Indication	Details		Indication	Details									
	3			0 or 1	Indoor 1	0		Default	0	Disuse (Soft Off + Hard Off)		Reserved						
							2				Indoor 2		1	2 °C	Standard	1	Off after 20 min (Soft Off + Hard Off)	
																2	Off after 40 min (Soft Off + Hard Off)	
				3	Off after 80 min (Soft Off + Hard Off)													
				4	Indoor 3	2	5 °C	Premium			4		Off after 20 min (Soft Off + Hard Off)					
											5		Off after 40 min (Soft Off + Hard Off)					
											6		Off after 80 min (Soft Off + Hard Off)					
				4	Indoor 4	2	5 °C	Standard			7		Off after 20 min (Soft Off only)					
											8		Off after 40 min (Soft Off only)					
											9		Off after 80 min (Soft Off only)					
				4	Indoor 4	2	5 °C	Premium			A		Off after 20 min (Soft Off only)					
											B		Off after 40 min (Soft Off only)					
											C		Off after 80 min (Soft Off only)					

Installation Procedure

- 1) SEG4

By SEG4 setting, Minimizing fan operation when thermostat is off.

- Fan operates for 20 seconds at an interval of 5 minutes in heat mode.
- Fan stops or operates Ultra low in Cooling when thermostat is off.

- 2) SEG8

Even if you set the Use of drain pump option to 0, it is automatically set to 2 (the drain pump is used with 3 minute delay).

- 3) SEG11

Compensation of the WindFree fan RPM option adjusts 20 rpm per 1 step.

- 4) SEG14

Example: When installing DPM (1 Outdoor unit with 4 indoor units)

Condition		SEG14 Setting				Result
External control	Level control	Indoor1	Indoor2	Indoor3	Indoor4	
Default		Not set (0)				Slave (All)
Disuse	Use	4	Not set (0)	Not set (0)	Not set (0)	Master (Indoor1), Slave (Indoor 2,3,4)
Use (Indoor3)	Disuse	Not set (0)	Not set (0)	1-3	Not set (0)	Slave (All)
Use (Indoor4)	Use	Not set (0)	Not set (0)	Not set (0)	5-7	Master (Indoor4), Slave (Indoor1,2,3)

- 5) SEG18

If you set the Maximum filter usage time option to a value other than 2 and 6, it is automatically set to 2 (1000 hours).

- 6) SEG20

If you set the Individual control with remote control option to a value other than 0 to 4, it is automatically set to 0 (Indoor1)

- 7) SEG21

Default value of Heating setting compensation is 5°C.

- 8) SEG23

Soft Off: The indoor unit turns off its operation at the indicated time in the table for Installation Option after its final motion detection. But, it turns on again if the MDS detects motion.

Hard Off: Designated time after SOFT OFF, it cannot turn on automatically when it detects motion. Users should control to turn on the indoor unit with remote control, etc.

Changing the addresses and options individually

When you want to change the value of a specific option, refer to the following table and follow the steps in **Common steps for setting the addresses and options** on page 18.

Option	SEG1		SEG2		SEG3		SEG4		SEG5		SEG6	
Function	Page		Mode		Option mode to change		Tens position of the option number		Units position of the option number		New value	
Indication and details	Indication	Details	Indication	Details	Indication	Details	Indication	Details	Indication	Details	Indication	Details
		0		D		Option type	0 to F	Tens position value	0 to 9	Units position value	0 to 9	New value

Example: Changing the Buzzer control (SEG17) option of the installation options to 1 disuse.

Option	SEG1	SEG2	SEG3	SEG4	SEG5	SEG6
Function	Page	Mode	Option mode to change	Tens position of the option number	Units position of the option number	New value
Indication	0	D	2	1	7	1

Step 15 Optional: Installing DPM (Digital Packaged Multi)



NOTE

To find DPM allowable indoor unit models according to outdoor unit models, refer to outdoor installation manual. Only AC052/071BN4PKG models are available to install DPM.

- When installing DPM, you should set "DPM setting" to the outdoor unit.
- You do not need to set the address manually for the indoor unit.
- If DPM model is not set, communication error may occur.
- While the outdoor unit is tracking the indoor unit for one minute after the power supply is turned on, the operation may stop if the remote control reception signal of the installed indoor unit is different.
- To enable Level control with the centralized controller, refer to page 25-26.



CAUTION

- When installing DPM, only one external controller can be connected.

Installation Procedure

Step 16 Optional : Setting the Emergency Temperature Output (ETO) function

⚠ CAUTION

- In order to deploy the ETO function, the MIM-B14, an external contact interface module, must be installed in each indoor unit.
- The ETO is a concept of emergency operation of indoor units. If the indoor unit 1 (main indoor unit) stops because of an error, the indoor unit 2 (sub indoor unit) starts to operate.
- Basically, the indoor unit 2 operates in the previous mode. [For the first time operation, it starts in 24 °C Auto mode.]
- To set more detailed operation conditions for the indoor unit 2, use the S-net Pro.

Setting up the ETO

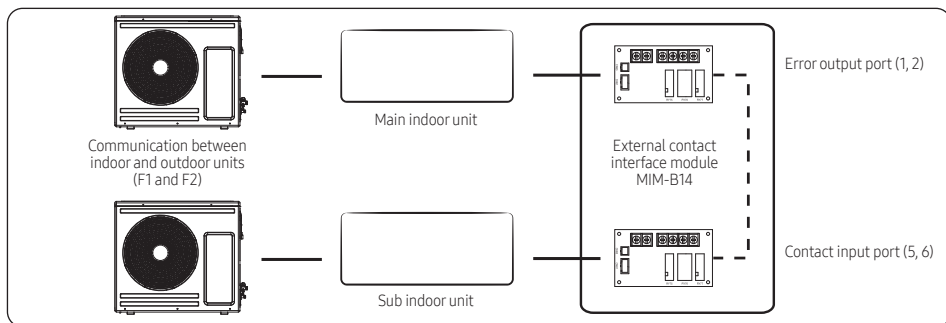

- 1 Main indoor unit
 - Disable the external contact control (Default).
 - Connect the S-net pro2 to F1 and F2.
 - Enable the ETO function and set the temperature and time.
- 2 Sub indoor unit
 - (Required) Enable the external contact control (with the installation option SEG14 - Reverse Control).
 - Connect the S-net pro2 to F1 and F2.
 - Enable the entrance control and set the mode, set temperature, and fan speed.

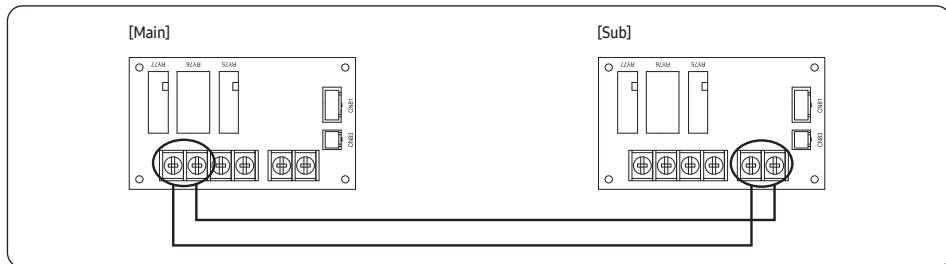

ETO operation specifications

- 1 Main indoor unit
 - Based on the external contact control settings, the main indoor unit decides whether to generate output when an error (indoor unit stop) occurs.
 - Based on the ETO settings, the main indoor unit decides whether to generate output according to the temperature and time conditions.
- 2 Sub indoor unit
 - Based on the entrance control settings, the sub indoor unit decides the mode, set temperature, and fan speed when contact inputs are given.

Main indoor unit	Enable of ETO	Enable of external contact	Error port output
	X	X	N/A
	X	O	Output due to an error
	O	X	Output by ETO entrance conditions (temperature / time / error occurrence)
	O	O	Output by ETO entrance conditions (temperature / time / error occurrence) * Ready to control the main contact input

Sub indoor unit	Enable of entrance control	Enable of external contact	Operation when outputting Main
	X	X	N/A
	X	O	On with the previous operation conditions
	O	O	On with the entrance control enabled



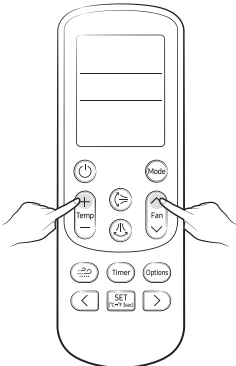
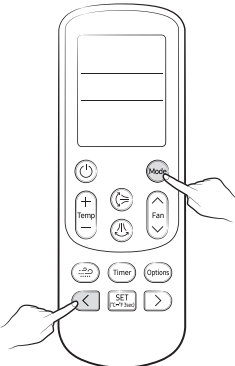

Step 17 Optional : LED Display indicator specifications when checking Wi-Fi Easy Setup and Wi-Fi status (This feature can be used when installing single Wi-fi kit)

The AR-EH04U wireless remote controller can be used for Easy Setup, checking internet connection status and connecting or disconnecting Wi-Fi.

Easy Setup	Check internet connection status	Connect/Disconnect to Wi-Fi
		
Press the [Timer] button for 5 seconds	Press the [+Temp] and [Fan] button simultaneously for 5 seconds	Press the [Mode] and [Left Arrow] button simultaneously for 5 seconds

Installation Procedure





LED Indicator Status

4way Cassette		LED Display				Remarks	Measure
		Operation	Defrost	Timer	Filter Cleaning		
							
Easy Setup	AP entry	●	●	●	●	All LED lights are on	-
	Check device	◐	◐	◐	◐	All LED lights flash	
	Registering devices	◐	◐	◐	◐	All LED lights flash one after another	
	Connected	◐	◐	◐	◐	All LED lights flash for 3 seconds	
	Connection failed	X	X	X	X	All LED lights turn off, and the system operates in the previous mode	AP settings, change Wi-Fi module
Check internet connection status	If AP/Internet is connected successfully	●	●	●	●	All LED lights turns on for 5 seconds	Normal operation
	If no AP connection	X	X	X	X	All LED turns off for 5 seconds	AP settings, change Wi-Fi module
Wi-Fi	If connected	◐	◐	◐	◐	All LED lights flashes once	-
	If not connected						-
If AP is set up using the wired remote controller		◐	◐	◐	◐	All LED lights flashes simultaneously (max. 5 mins)	-

Installation Procedure

Appendix

Troubleshooting

Abnormal conditions	LED lamp display				Remarks
	Operation	Defrost	Timer	Filter	
					
Power reset	●	X	X	X	
Error of temperature sensor in the indoor unit (Open/Short)	X	●	X	X	
Error of heat exchanger sensor in the indoor unit (Open/Short)	●	●	X	X	
Error of fan motor in the indoor unit	X	X	●	X	
Error of the outdoor temperature sensor Error of the condensor temperature sensor Error of the discharge temperature sensor	●	X	●	X	
No communication for 2 minutes between indoor and outdoor unit (communication error for more than 2 minutes)	X	●	●	X	
Error of outdoor unit Error of the terminal block thermal fuse (Open)	X	●	●	●	
Detection of the float switch	X	X	●	●	
EEPROM ERROR EEPROM option error	●	●	●	●	
Outdoor valve clogging error	●	X	●	●	
MDS (Motion Detecting Sensor) Error	●	X	X	●	
Error due to connecting outdoor units that do not support the WindFree function	●	●	X	●	

● : On, ◐ : Flickering, X : Off

If you turn off the air conditioner when the LED is flickering, the LED is also turned off.



This appliance is filled with R-32.