

# Air conditioner

---

## Installation manual

AC\*\*\*BN6PKG

---

- Thank you for purchasing this Samsung air conditioner.
- Before operating this unit, please read this Installation manual carefully and retain it for future reference.



**SAMSUNG**

# Contents

---

<b>Safety Information</b>	<b>3</b>
<b>Installation Procedure</b>	<b>6</b>
Step 1 Checking and preparing accessories	6
Step 2 Choosing the installation location	6
Step 3 Optional: Insulating the body of the indoor unit	10
Step 4 Installing the indoor unit	10
Step 5 Optional: For the installation of the circular panel	12
Step 6 Purging inert gas from the indoor unit	12
Step 7 Cutting and flaring the pipes	13
Step 8 Connecting the assembly pipes to the refrigerant pipes	13
Step 9 Performing the gas leak test	14
Step 10 Insulating the refrigerant pipes	14
Step 11 Installing the drain hose and drain pipe	16
Step 12 Performing the drainage test	18
Step 13 Connecting the power and communication cables	19
Step 14 Optional: Extending the power cable	22
Step 15 Setting the indoor unit addresses and the installation options	23
Step 17. Optional : Setting the Emergency Temperature Output (ETO) function	38
Step 18. Optional : LED Display indicator specifications when checking Wi-Fi Easy Setup and Wi-Fi status (This feature can be used when installing single Wi-fi kit)	40
<b>Appendix</b>	<b>41</b>
<b>Troubleshooting</b>	<b>41</b>

# Safety Information

---

## WARNING

- Hazards or unsafe practices that may result in severe personal injury or death.

## CAUTION

- Hazards or unsafe practices that may result in minor personal injury or property damage.
- Carefully follow the precautions listed below because they are essential to guarantee the safety of the equipment.

## WARNING

- Always disconnect the air conditioner from the power supply before servicing it or accessing its internal components.
- Verify that installation and testing operations are performed by qualified personnel.
- Verify that the air conditioner is not installed in an easily accessible area.

## General information

---

## WARNING

- Carefully read the content of this manual before installing the air conditioner and store the manual in a safe place in order to be able to use it as reference after installation.
- For maximum safety, installers should always carefully read the following warnings.
- Store the operation and installation manual in a safe location and remember to hand it over to the new owner if the air conditioner is sold or transferred.
- This manual explains how to install an indoor unit with a split system with two SAMSUNG units. The use of other types of units with different control systems may damage the units and invalidate the warranty. The manufacturer shall not be responsible for damages arising from the use of non compliant units.
- The manufacturer shall not be responsible for damage originating from unauthorized changes or the improper connection of electric and requirements set forth in the "Operating limits" table, included in the manual, shall immediately invalidate the warranty.
- The air conditioner should be used only for the applications for which it has been designed: the indoor unit is not suitable to be installed in areas used for laundry.
- Do not use the units if damaged. If problems occur, switch the unit off and disconnect it from the power supply.
- In order to prevent electric shocks, fires or injuries, always stop the unit, disable the protection switch and contact SAMSUNG's technical support if the unit produces smoke, if the power cable is hot or damaged or if the unit is very noisy.
- Always remember to inspect the unit, electric connections, refrigerant tubes and protections regularly. These operations should be performed by qualified personnel only.
- The unit contains moving parts, which should always be kept out of the reach of children.
- Do not attempt to repair, move, alter or reinstall the unit. If performed by unauthorized personnel, these operations may cause electric shocks or fires.
- Do not place containers with liquids or other objects on the unit.
- All the materials used for the manufacture and packaging of the air conditioner are recyclable.
- The packing material and exhaust batteries of the remote controller(optional) must be disposed of in accordance with current laws.
- The air conditioner contains a refrigerant that has to be disposed of as special waste. At the end of its life cycle, the air conditioner must be disposed of in authorised centres or returned to the retailer so that it can be disposed of correctly and safely.
- Wear protective equipment (such as safety gloves, goggles, and headgear) during installation and maintenance works. Installation/repair technicians may be injured if protective equipment is not properly equipped.
- Do not use means to accelerate the defrost operation or to clean, other than those recommended by Samsung.
- Do not pierce or burn.
- Be aware that refrigerants may not contain an odour.

# Safety Information

## Installing the unit

### WARNING

**IMPORTANT:** When installing the unit, always remember to connect first the refrigerant tubes, then the electrical lines.

- Always disassemble the electric lines before the refrigerant tubes.
- Upon receipt, inspect the product to verify that it has not been damaged during transport. If the product appears damaged, DO NOT INSTALL it and immediately report the damage to the carrier or retailer (if the installer or the authorized technician has collected the material from the retailer.)
- After completing the installation, always carry out a functional test and provide the instructions on how to operate the air conditioner to the user.
- Do not use the air conditioner in environments with hazardous substances or close to equipment that release free flames to avoid the occurrence of fires, explosions or injuries.
- Do not install the product in a place where thermohygrostat is needed (such as server room, machinery room, computer room, etc.) Those places do not provide guaranteed operation condition of the product therefore performance can be poor in these places.
- Do not install the product in a ship or a vehicle (such as a campervan). Salt, vibration or other environmental factor may cause the product malfunction, electric shock or fire.
- Excessive indoor humidity or clogged condensate drain lines may cause water to drip from indoor units. Do not install the indoor unit where dripping could result in damage to property, such as above electronic equipment or other sensitive instruments.
- Our units should be installed in compliance with the spaces shown in the installation manual, to ensure accessibility from both sides and allow repairs or maintenance operations to be carried out. The unit's components should be accessible and easy to disassemble without endangering people and objects. For this reason, when provisions of the installation manual are not complied with, the cost required to access and repair the units (in SAFETY CONDITIONS, as set out in prevailing regulations) with harnesses, ladders, scaffolding or any other elevation system will NOT be considered part of the warranty and will be charged to the end customer.

## Power supply line, fuse or circuit breaker

### WARNING

- Always make sure that the power supply is compliant with current safety standards. Always install the air conditioner in compliance with current local safety standards.
- Always verify that a suitable grounding connection is available.
- Verify that the voltage and frequency of the power supply comply with the specifications and that the installed power is sufficient to ensure the operation of any other domestic appliance connected to the same electric lines.
- Always verify that the cut-off and protection switches are suitably dimensioned.
- Verify that the air conditioner is connected to the power supply in accordance with the instructions provided in the wiring diagram included in the manual.
- Always verify that electric connections (cable entry, section of leads, protections...) are compliant with the electric specifications and with the instructions provided in the wiring scheme. Always verify that all connections comply with the standards applicable to the installation of air conditioners.
- Devices disconnected from the power supply should be completely disconnected in the condition of overvoltage category.
- Be sure not to perform power cable modification, extension wiring, and multiple wire connection.
  - It may cause electric shock or fire due to poor connection, poor insulation, or current limit override.
  - When extension wiring is required due to power line damage, refer to "**Step 14 Optional: Extending the power cable**" in the installation manual.

---

 **CAUTION**

**Make sure that you earth the cables.**

- Do not connect the earth wire to the gas pipe, water pipe, lighting rod or telephone wire. If earthing is not complete, electric shock or fire may occur.

**Install the circuit breaker.**

- If the circuit breaker is not installed, electric shock or fire may occur.

**Make sure that the condensed water dripping from the drain hose runs out properly and safely.**

**Install the power cable and communication cable of the indoor and outdoor unit at least 1m away from the electric appliance.**

**Install the indoor unit away from lighting apparatus using the ballast.**

- If you use the wireless remote control, reception error may occur due to the ballast of the lighting apparatus.





**Do not use the indoor unit for preservation of food items, plants, equipment, and art works. This may cause deterioration of their quality.**

**Do not install the indoor unit if it has any drainage problem.**

# Installation Procedure

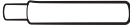
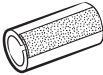
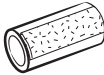
## Step 1 Checking and preparing accessories

The following accessories are supplied with the indoor unit. The type and quantity may differ, depending on the specifications.

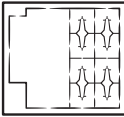
Pattern sheet A (1) Pattern sheet B (1)	Drain hose
	
Insulation pipe (Liquid side1, gas side1)	Insulation drain hose (1)
	
Installation manual	User manual
	
Cable-tie	Clamp
	
Installation gauge(1)	
	

## Step 2 Choosing the installation location

### Installation location requirements

- There must be no obstacles near the air inlet and outlet.
- Install the indoor unit to a ceiling that can support its weight.
- Maintain sufficient clearance around the indoor unit.
- Before installing the indoor unit, be sure to check whether the chosen location has proper drainage possibilities.
- The indoor unit must be installed such that it is beyond public access and is not touchable by users.
- A vibration-resistant location that is not inclined (If the indoor unit is installed on a structure that is not sturdy, it may fall and get damaged or cause injury.)
- Where it is not exposed to direct sunshine.
- Where the air filter can be removed and cleaned easily.
- A location where animals cannot access and urinate on the product. Ammonia may be generated.

## WARNING

- Because your air conditioner contains R-32 refrigerant, make sure that it is installed, operated, and stored in a room whose floor area is larger than the minimum required floor area specified in the following table:

m (kg)	Ceiling-mounted type (A, m <sup>2</sup> )
≤1.842	No requirement
1.843	3.64
1.9	3.75
2.0	3.95
2.2	4.34
2.4	4.74
2.6	5.13
2.8	5.53
3.0	5.92
3.2	6.48
3.4	7.32
3.6	8.20
3.8	9.14
4.0	10.1
4.2	11.2
4.4	12.3
4.6	13.4
4.8	14.6
5.0	15.8
5.2	17.1
5.4	18.6
5.6	20.0
5.8	21.5
6.0	23.0

- m : Total refrigerant charge in the system
- A : Minimum required floor area
- IMPORTANT: it's mandatory to consider either the table above or taking into consideration the local law regarding the minimum living space of the premises.
- Minimum installation height of indoor unit is 0.6 m for floor mounted, 1.8 m for wall, 2.2 m for ceiling.

## CAUTION

- As a rule, the unit cannot be installed at a height of less than 2.5m.
- If you install the cassette or duct type indoor unit on the ceiling with humidity over 80%, you must apply extra 10mm of polyethylene foam or other insulation with similar material on the body of the indoor unit.

### Do not install the air conditioner in following places.

- Place where there is mineral oil or arsenic acid. Resin parts flame and the accessories may drop or water may leak. The capacity of the heat exchanger may reduce or the air conditioner may be out of order.
- A place with exposure to mineral oil, oil vapour or cooking area where there is spray (If oil adheres to the heat exchanger, performance degradation, spray or condensation scattering may occur. If oil adheres to a plastic component, the component may deform or get damaged. Such issues may result in a system failure or refrigerant leak.)
- A place with aromatic diffusers, aromatherapy, scented candles or perfumes as the chemicals may react to the product's materials and may result in system failure or refrigerant leaks.
- The place where corrosive gas such as sulphuric acid gas generates from the vent pipe or air outlet.
- The copper pipe or connection pipe may corrode and refrigerant may leak.
- The place where there is a machine that generates electromagnetic waves. The air conditioner may not operate normally due to control system.
- The place where there is a danger of existing combustible gas, carbon fibre or flammable dust.
- The place where thinner or gasoline is handled. Gas may leak and it may cause fire.
- The place where is close to heat sources.
- Do not use the indoor unit for preservation of food items, plants, equipment, and art works. This may cause deterioration of their quality.
- Do not install the indoor unit if it has any drainage problem.

# Installation Procedure

## Indoor unit dimensions

(Unit: mm)

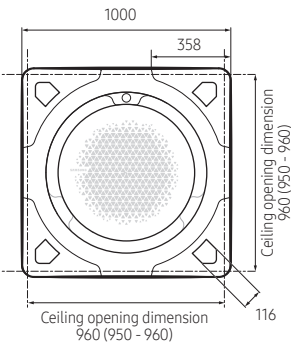
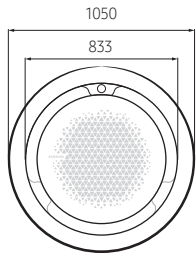
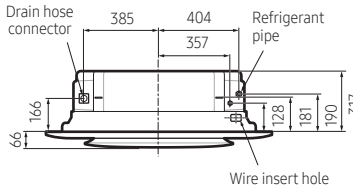
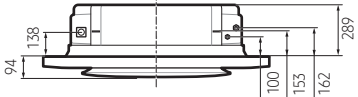
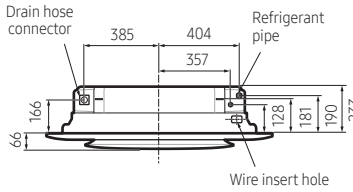
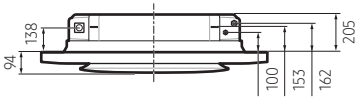
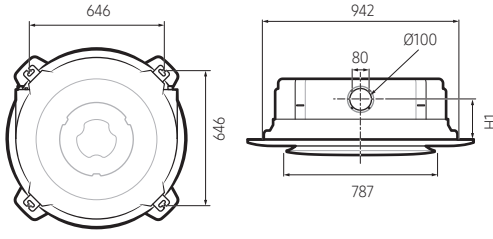
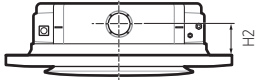
Category	Square panel	Circular panel
Front		
Large+		
Small		
Common		 <p>H1 → Large+: 180, Small: 150 H2 → Large+: 152, Small: 122</p>
	Square panel	Circular panel



Model		AC052BN6PKG	AC071BN6PKG	AC100BN6PKG	AC120BN6PKG	AC140BN6PKG
Chassis		Small	Large+			
Net dimension (W x D x H)	mm	947 x 947 x 281		947 x 947 x 365		
Liquid pipe connection	mm	6.35		9.52		
Gas pipe connection	mm	12.7		15.88		
Drain hose connection	mm	VP25 (OD32, ID26.5)				

- The circular panel is by default available in exposed installation.
- Make inspection holes on the ceiling for easier installation and maintenance, as shown in the following table. (The size of an inspection hole must be at least 450 mm x 450 mm.)
- A suspended ceiling structure can substitute for the inspection holes.

Category	Inspection hole		
	Recessed installation		Exposed installation
	Integrated	suspended	
Square panel	1 ea	-	
Circular panel	2 ea		

- For the recessed installation of the circular panel

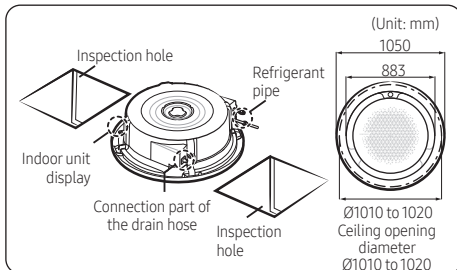

#### NOTE

- The clearance between the panel and the inspection hole is 15 to 20 mm on a side.

## Spacing requirements

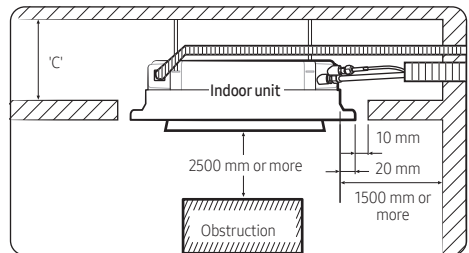
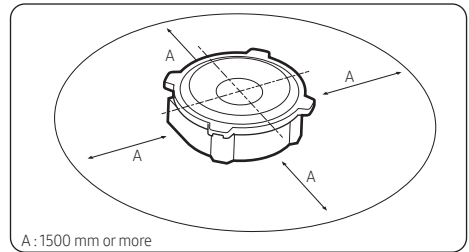

(Unit: mm)		
Model	AC052BN6PKG	AC071BN6PKG AC100BN6PKG AC120BN6PKG AC140BN6PKG
C	261	345

# Installation Procedure

## ⚠ CAUTION

- Comply with the length and height limits described in the figure above.
- For the product that uses the R-32 refrigerant, install the indoor unit on the wall 1.8 m or higher from the floor.
- The indoor unit must be installed according to the specified distances in order to permit accessibility from each side, to guarantee correct operation, maintenance, and repair of the unit.  
The components of the indoor unit must be reachable and removable under safe conditions for people and the unit.
- Do not carry the unit by holding the refrigerant or drain pipes to avoid product damage.
- Carry the unit by holding the hanger plates located on the corners of the unit.

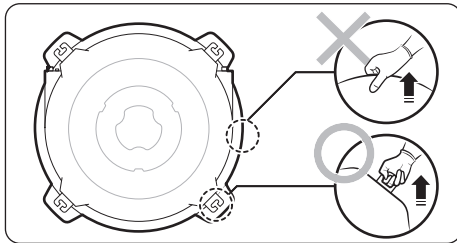

## Step 3 Optional: Insulating the body of the indoor unit

If you install a cassette type indoor unit on the ceiling when temperature is over 27°C and humidity is over 80%, you must apply an extra 10 mm thick polyethylene insulation or a similar type of insulation to the body of the indoor unit.

Cut away the part where pipes are pulled out for the insulating work.

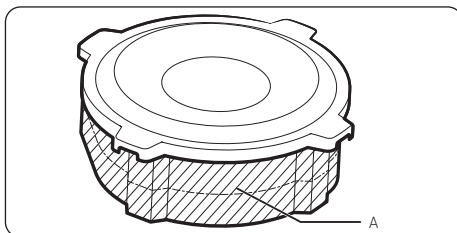

Insulate the end of the pipe and some curved area by using separate insulator.

## 📖 NOTE

- A: Reference for the outer circumference of the unit (When insulating the body of the indoor unit, use A as the reference for its outer circumference.)

(Unit: mm)

Indoor unit type and models		Dimensions
360 cassette type <S> (947 x 947 x 281)	AC052BN6PKG	2610 x 130
360 cassette type <L+> (947 x 947 x 365)	AC071BN6PKG	2610 x 215
	AC100BN6PKG	
	AC120BN6PKG	
	AC140BN6PKG	

## Step 4 Installing the indoor unit

When deciding on the location of the air conditioner the following restrictions must be taken into account.

- Determine the positions of the pipe and the drain hose hole as shown in the pattern sheet, and drill the hole with an inner diameter of 14 mm.

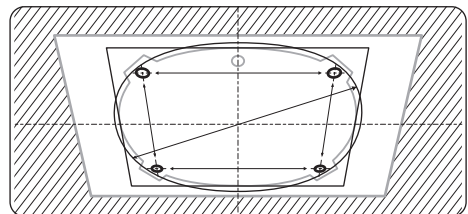

## 📖 NOTE

- Since the diagram is made of paper, it may shrink or stretch slightly due to temperature or humidity. For this reason, before drilling the holes, be sure to maintain the correct dimensions between the markings.

2 Perform the following steps to install inspection holes in accordance with the panel type.

- a For the recessed installation of the square panel.
- Install an inspection hole to the direction of connection parts of the refrigerant pipe and the drain hose. (1 point)

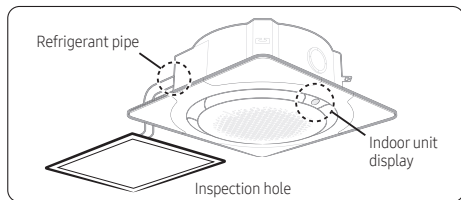

- b For recessed installation of the circular panel
- Install inspection holes to both directions of the connection part of the refrigerant pipe and the drain hose and of the indoor unit display. (2 points)

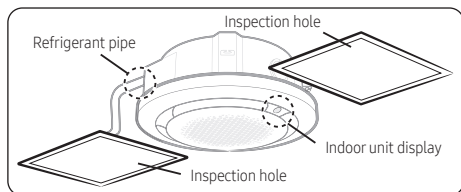

3 Insert bolt anchors, use existing ceiling supports or construct a suitable support as shown in figure.

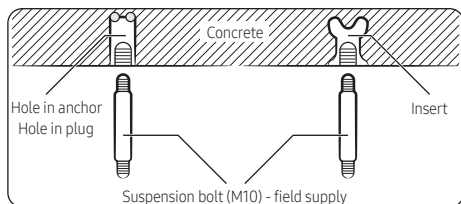

4 Install the suspension bolts, depending on the ceiling type.

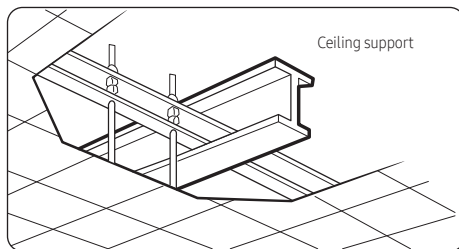

**CAUTION**

- Make sure that the ceiling is strong enough to support the weight of the indoor unit. Before hanging the unit, test the strength of each attached suspension bolt.
- If the length of the suspension bolt is more than 1.5 m, you are required to prevent vibration.

5 Screw eight pairs of nuts and washers to the suspension bolts, making space for hanging the indoor unit.

**CAUTION**

- You must install all of the suspension rods.
- It is important to leave sufficient space in the false ceiling to allow access for maintenance or repairs to the drainage pipe connection, the refrigerant pipe connection, or to remove the unit if necessary.

6 Hang the indoor unit to the suspension bolts between two nuts. Cut a pad stopper and place it on the suspension bolts to hold the washers. Remove the stopper and screw the nuts to fix the unit.

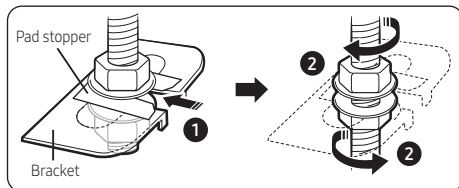

# Installation Procedure

- Adjust the unit to the appropriate position, taking into account the installation area for the front panel.
  - Place the pattern sheet on the indoor unit.
  - Adjust the space between the ceiling and the indoor unit by using a dimension gauge.
  - Fix the indoor unit securely after adjusting the level of the unit by using a leveller.
  - Remove the pattern sheet, connect the other cables, and install the front panel.

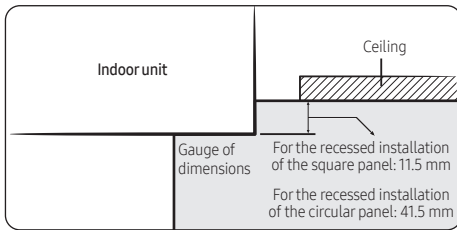

- Rotate the paper compass on its pivot point to draw a line on the ceiling.

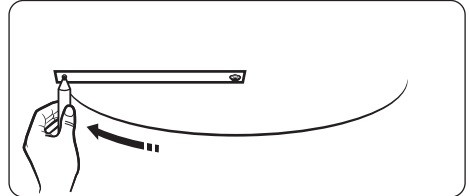

- Rotate the paper compass diametrically to draw a circle on the ceiling.

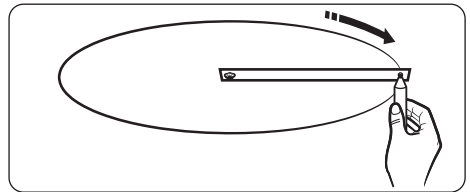

## Step 5 Optional: For the installation of the circular panel

### Making a circular opening on the ceiling

Use a paper compass printed on the indoor unit package. (attached inside to the upper part)

- Use a bolt or a pin to fix pivot point of the paper compass on center of the ceiling. (in the middle of location for installation)

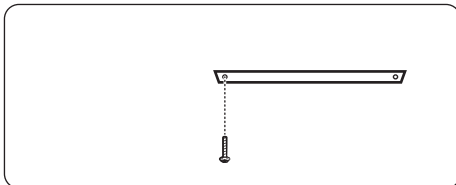

- Put a pencil at the opposite side of the pivot point fixed in place.

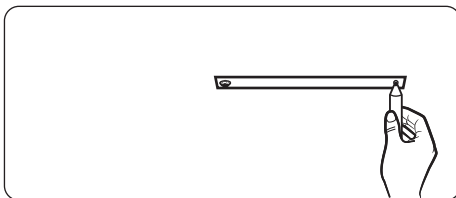

### For the painting of the panel

- Make sure to only apply paints and varnishes for resins (ABS, HIPS) or paint thinners.
- If you apply lacquers for general use on the panel, it may lead to discoloration or erosion on the surface of the panel.

## Step 6 Purging inert gas from the indoor unit

The indoor unit comes with nitrogen gas (inert gas) charged at the factory. Therefore, all inert gas must be purged before connecting the assembly piping.

Unscrew the pinch pipe at the end of each refrigerant pipe.

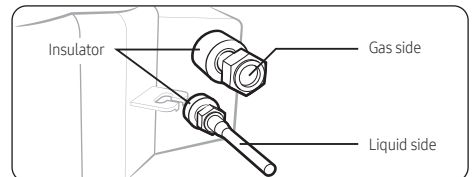

### NOTE

- To prevent dirt or foreign objects from getting into the pipes during installation, do not remove the pinch pipe completely until you are ready to connect the piping.

## Step 7 Cutting and flaring the pipes

- 1 Make sure that you have the required tools available: pipe cutter, reamer, flaring tool, and pipe holder.
- 2 If you wish to shorten the pipes, cut them with a pipe cutter, ensuring that the cut edge remains at a 90° angle to the side of the pipe. Refer to the illustrations below for examples of edges cut correctly and incorrectly.

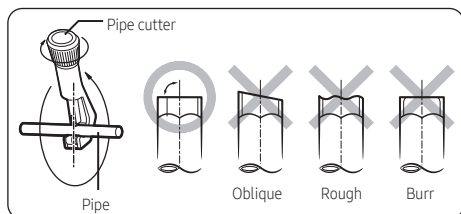

- 3 To prevent any gas from leaking out, remove all burrs at the cut edge of the pipe, using a reamer.
- 4 Slide a flare nut on to the pipe and modify the flare.

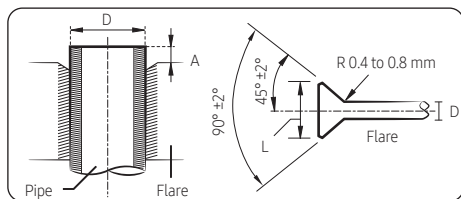

(Unit: mm)

Outer Diameter (D)	Depth (A)	Flare dimension (L)
Ø6.35	1.3	8.7 to 9.1
Ø9.52	1.8	12.8 to 13.2
Ø12.70	2.0	16.2 to 16.6
Ø15.88	2.2	19.3 to 19.7
Ø19.05	2.2	23.6 to 24.0

- 5 Check that the flaring is correct, referring to the illustrations below for examples of incorrect flaring.

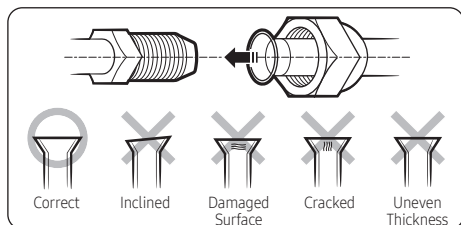

## Step 8 Connecting the assembly pipes to the refrigerant pipes

There are two refrigerant pipes of different diameters :

- A smaller one for the liquid refrigerant.
- A larger one for the gas refrigerant. The inside of copper pipe must be clean and has no dust.

- 1 Remove the pinch pipe on the pipes and connect the assembly pipes to each pipe, tightening the nuts, first manually and then with a torque wrench, a spanner applying the following torque.

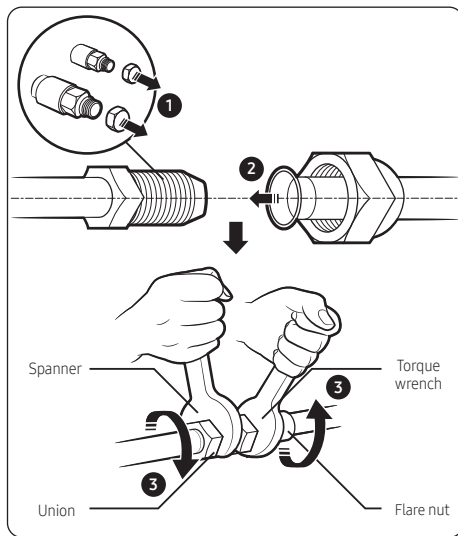

Outer Diameter (mm)	Torque (N•m)
Ø6.35	14 to 18
Ø9.52	34 to 42
Ø12.70	49 to 61
Ø15.88	68 to 82
Ø19.05	100 to 120

(1 N•m=10 kgf•cm)

### NOTE

- If the pipes must be shortened, see **Step 7 Cutting and flaring the pipes** on page 13.

# Installation Procedure

- 2 Be sure to use an insulator thick enough to cover the refrigerant tube to protect the condensate water on the outside of the pipe falling onto the floor and to improve the efficiency of the unit.
- 3 Cut off any excess foam insulation.
- 4 Make sure that there are no cracks or waves on the bent area.
- 5 It would be necessary to double the insulation thickness (10 mm or more) to prevent condensation even on the insulator when if the installed area is warm and humid.
- 6 Do not use joints or extensions for the pipes connecting the indoor and outdoor units. The only permitted connections are those for which the units are designed.



## CAUTION

- Connect the indoor and outdoor units using pipes with flared connections (not supplied). For the lines, use insulated, unwelded, degreased and deoxidized copper pipe (Cu DHP type to ISO 1337 or UNI EN 12735-1), suitable for operating pressures of at least 4.2 MPa and for a burst pressure of at least 20.7 MPa. Copper pipe for hydro-sanitary applications is completely unsuitable.
- For sizing and limits (height difference, line length, max. bends, refrigerant charge, etc.) see the outdoor unit installation manual.
- All refrigerant connection must be accessible, in order to permit either unit maintenance or removing it completely.
- If the pipes require brazing, make sure that oxygen free nitrogen (OFN) is flowing through the system.
- Nitrogen blowing pressure range is 0.02 to 0.05 MPa.

## Step 9 Performing the gas leak test

To identify potential gas leaks on the indoor unit, inspect the connection area of each refrigerant pipe using a leak detector for R-32.

Before recreating the vacuum and recirculating the refrigerant gas, pressurize the whole system with nitrogen (using a cylinder with a pressure reducer) at a pressure above 4 MPa in order to immediately detect leaks on the refrigerant fittings.

Made vacuum for 15 minutes and pressurizing system with nitrogen.

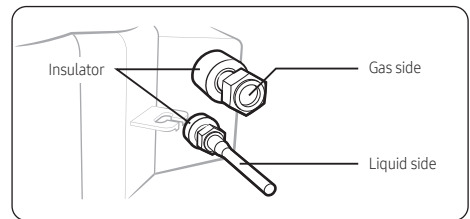

## Step 10 Insulating the refrigerant pipes

Once you have checked that there are no leaks in the system, you can insulate the piping and hose.

- 1 To avoid condensation problems, place Acrylonitrile Butadien Rubber separately around each refrigerant pipe.

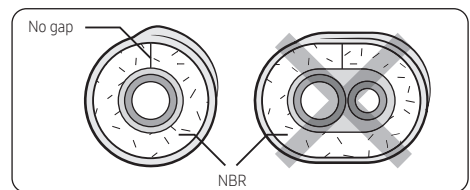

## NOTE

- Always make the seam of pipes face upwards.

- 2 Wind insulating tape around the pipes and drain hose avoiding compressing the insulation too much.

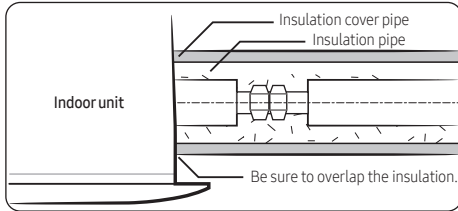

### ⚠ CAUTION

- Be sure to wrap insulation tightly without any gaps.
- 3 Finish wrapping insulating tape around the rest of the pipes leading to the outdoor unit.
- 4 The pipes and electrical cables connecting the indoor unit with the outdoor unit must be fixed to the wall with suitable ducts.

### ⚠ CAUTION

- Make sure that all refrigerant connection must be accessible for easy maintenance and detachment.
- Install the insulation not to get wider and use the adhesives on the connection part of it to prevent moisture from entering.
- Wind the refrigerant pipe with insulation tape if it is exposed to outside sunlight.
- Install the refrigerant pipe respecting that the insulation does not get thinner on the bent part or hanger of pipe.
- Add the additional insulation if the insulation plate gets thinner.

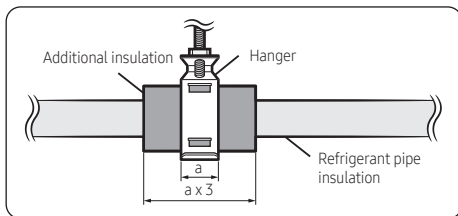

- 5 Select the insulation of the refrigerant pipe.

- Insulate the gas side and liquid side pipe, noting the insulation thickness that must differ according to the pipe size.
- Standard: Less than an indoor temperature of 30°C, with humidity at 85%. If installing in a high humidity environment, use one grade thicker insulator by referring to the table below. If installing in an unfavourable environment, use thicker one.
- The heat-resistance temperature of the insulator must be more than 120°C.

### ⚠ CAUTION

- Must fit tightly against body without any gap.
- All refrigerant connection must be accessible, in order to permit either unit maintenance or removal.

# Installation Procedure

Pipe	Pipe size (mm)	Insulation type (heating/cooling)		Remarks
		Standard (Less than 30°C, 85%)	High humidity (Over 30°C, 85%)	
		EPDM, NBR (mm)		
Liquid pipe	Ø6.35 to Ø9.52	9t	9t	The internal temperature is higher than 120°C.
	Ø12.7 to Ø19.05	13t	13t	
Gas pipe	Ø6.35	13t	19t	
	Ø9.52	19t	25t	
	Ø12.70			
	Ø15.88			
Ø19.05				

- When installing insulation in the places and conditions below, use the same insulation that is used for high humidity conditions.

<Geological condition>
High humidity locations such as shorelines, hot springs, lake or riversides, and ridges (when part of the building is covered by earth and sand)
<Operation purpose condition>
Restaurant ceiling, sauna, swimming pool etc.
<Building construction condition>
Ceilings frequently exposed to moisture and cooling are not covered. For example, pipes installed at a corridor of a dormitory and studio or near an exit that opens and closes frequently.
Places (where the pipes are installed) that are highly humid due to a lack of ventilation.

## Step 11 Installing the drain hose and drain pipe

- Push the supplied drain hose as far as possible over the drain socket.
- Tighten the metal clamp as shown in the picture.

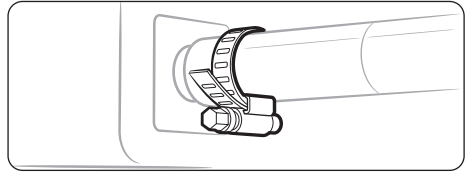

- Wrap the supplied large sealing pad over the metal clamp and drain hose to insulate and fix it with clamps.
- Insulate the complete drain piping inside the building (field supply).  
If the drain hose cannot be sufficiently set on a slope, fit the hose with drain raising piping (field supply).
- Push the drain hose up to insulation when connecting the drain hose to drain socket.

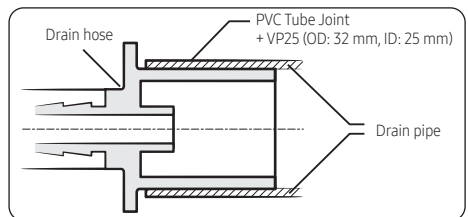
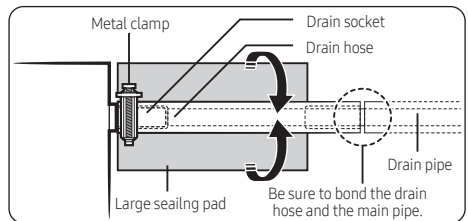

### CAUTION

Check that the indoor unit is level with the ceiling by using the leveller.



- Install air ventilation to drain condensation smoothly.

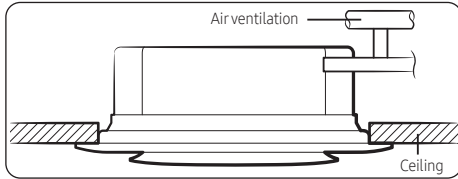

- If it is necessary to increase the height of the drain pipe, install the drain pipe straight within 300 mm from the drain hose port. If it is raised higher than 550 mm, there may be water leaks.

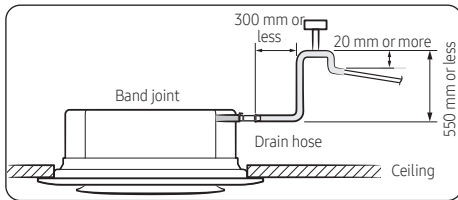

- Do not give the hose an upward gradient beyond the connection port. This will cause water to flow backwards when the unit is stopped, resulting in water leaks.

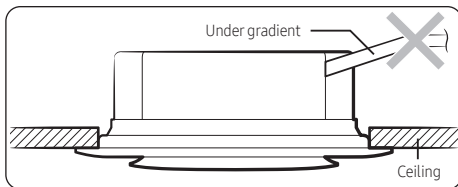

- Do not apply force to the piping on the unit side when connecting the drain hose. The hose should not be allowed to hang loose from its connection to the unit. Fasten the hose to a wall, frame or other support as close to the unit as possible.

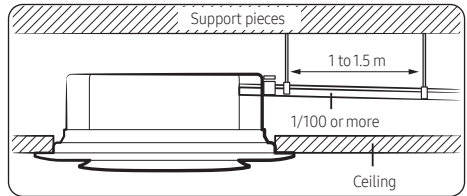

- Install horizontally.

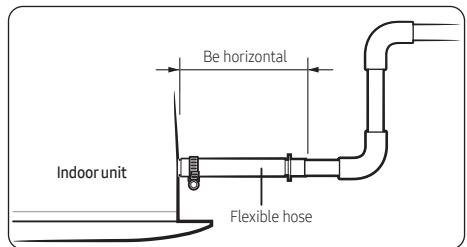

- Max. allowable axis gap.

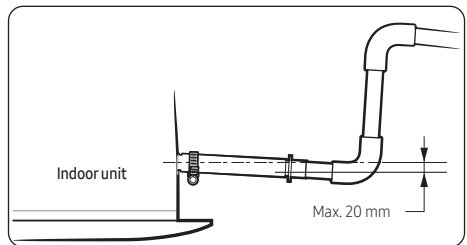

- Max. allowable bending angle.

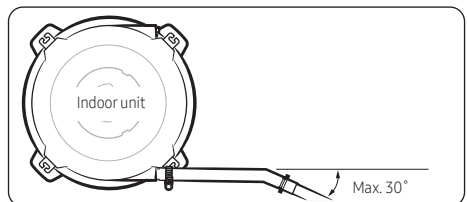

# Installation Procedure

## NOTE

- If a concentrated drain pipe is installed, refer to the figure below.

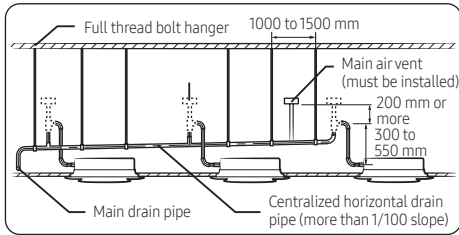

## Step 12 Performing the drainage test

- 1 Do a leak test at the connection part of the flexible hose and the drain pipe:

- a Connect a general hose to the connection part of the flexible hose of the indoor unit, and pour in some water.

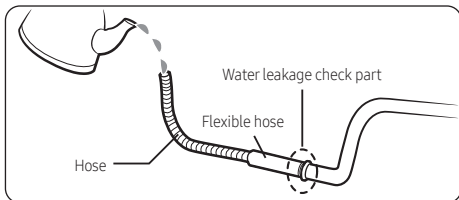

- b After pouring some water, reassemble the rubber cap on the connection part of a flexible hose of the indoor unit and firmly tighten it with a band to prevent leakage.
- c Check the leak test at the part where the adhesive for the flexible hose and the drain pipe is used.

## CAUTION

- The leak test must be performed for at least 24 hours.

- 2 Check the condensed water drainage:

- a Pour about 2 liters of water into the indoor unit drain pan as shown in the picture.

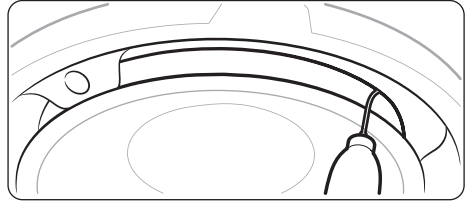

- b When the electric cable connection is completed
  - Turn on the indoor unit and outdoor unit.
  - Operate in the Cool mode.

## CAUTION

- Only in the Cool mode, you can check the correct operation of the drain pump.

When the electric cable connection has not been completed

- Remove the control box cover of the indoor unit.
- Connect the power supply (220~240V, 50 Hz) to the L and N terminals.
- Reassemble the control box cover and turn on the indoor unit.

## CAUTION

- When the float switch is not detected due to insufficient water on the drain pan, the drain pump will not work.
- If the power supply is directly connected to the L and N terminals, communication error message might appear.
- After completing the drainage check, turn the unit off and disconnect the power supply.
- Reassemble the control box cover.

- c Check whether the drain pump works correctly.
- d Check whether the drainage is performing correctly at the end of the drain pipe.
- e Check for leakage at the drain pipe and drain pipe connection part.
- f When leakage occurs, check whether the indoor unit is level and check the drain hose connection part, drainpipe connection part and drain pump connection.
- g When the drainage check is completed and the condensed water remains on the drain pan, remove the water.

## Step 13 Connecting the power and communication cables

### ⚠ CAUTION

- Always remember to connect the refrigerant pipes before performing the electric connections. When disconnecting the system, always disconnect the electric cables before disconnecting the refrigerant pipes.
- For the product that uses the R-32 refrigerant, be cautious not to generate a spark by keeping the following requirements:
  - Do not remove the fuses with power on.
  - Do not disconnect the power plug from the wall outlet with power on.
  - It is recommended to locate the outlet in a high position. Place the cords so that they are not tangled.
- Always remember to connect the air conditioner to the grounding system before performing the electric connections. Use a crimp ring terminal at the end of each wire.

The indoor unit is powered through the outdoor unit by means of a H07 RN-F connection cable (or a more power model), with insulation in synthetic rubber and a jacket in polychloroprene (neoprene), in accordance with the requirements specified in the standard EN 60335-2-40.

- 1 Remove the screw on the electrical component box and remove the cover plate.
- 2 Route the connection cord through the side of the indoor unit and connect the cable to the terminals refer to the figure below.
- 3 Route the other end of the cable to the outdoor unit through the ceiling & the hole on the wall.
- 4 Reassemble the electrical component box cover, carefully tightening the screw.

### Wiring terminals) 1 phase

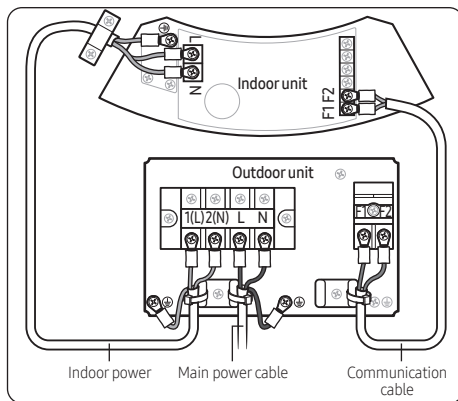

### Wiring terminals) 3 phase

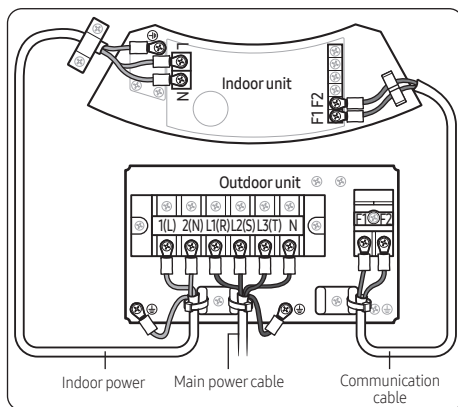

# Installation Procedure

**NOTE**

- Insert the power and the communication cables to the cable insert hole, then arrange and connect the cables, as shown in the figure:

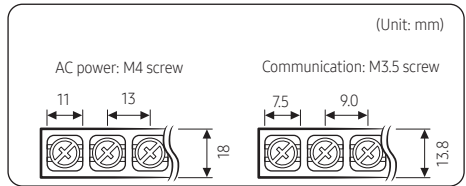
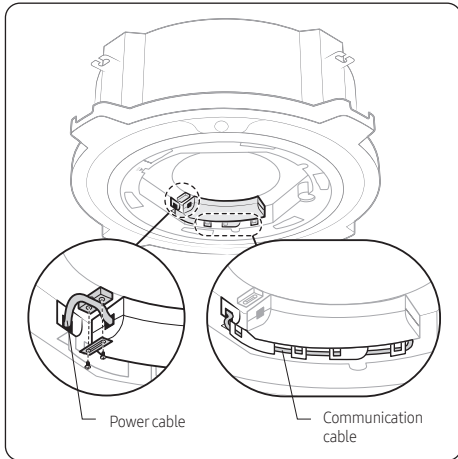
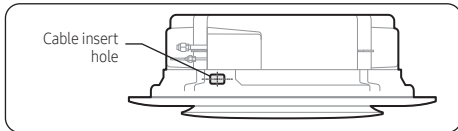

Tightening torque (kgf • cm)	
M3.5	8.0 to 12.0
M4	12.0 to 18.0

- 1 N·m = 10 kgf·cm
- Power supply cords of parts of appliances for outdoor use shall not be lighter than polychloroprene sheathed flexible cord. (Code designation IEC:60245 IEC 57 / CENELEC: H05RN-F or IEC:60245 IEC 66 / CENELEC: H07RN-F)
- Since it has the external power supply, refer to the outdoor unit installation manual for MAIN POWER.

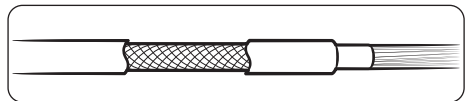

**CAUTION**

- When installing the indoor unit in a computer room or network room, use the double shielded communication cable (tape aluminum / polyester braid + copper) of FROHH2R or LiYCY type.

Indoor power supply		
Power supply	Max/Min(V)	Indoor power cable
220 to 240V, 50 Hz	±10%	0.75 mm <sup>2</sup> ↑, 3 wires
Communication cable		
0.75 mm <sup>2</sup> , 2 wires		

## Wiring work

### Selecting compressed ring terminal

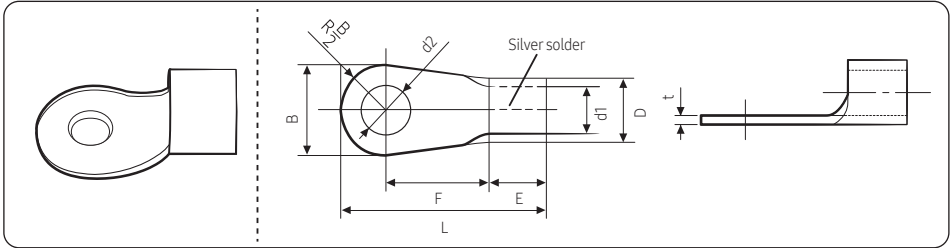





Nominal dimensions for cable (mm <sup>2</sup> )		1.5		2.5		4
Nominal dimensions for screw (mm)		4	4	4	4	4
B	Standard dimension (mm)	6.6	8.0	6.6	8.5	9.5
	Allowance (mm)	±0.2		±0.2		±0.2
D	Standard dimension (mm)	3.4		4.2		5.6
	Allowance (mm)	+0.3 -0.2		+0.3 -0.2		+0.3 -0.2
d1	Standard dimension (mm)	1.7		2.3		3.4
	Allowance (mm)	±0.2		±0.2		±0.2
E	Min. (mm)	4.1		6		6
F	Min. (mm)	6		6		6
L	Max. (mm)	16		17.5		20
d2	Standard dimension (mm)	4.3		4.3		4.3
	Allowance (mm)	+0.2 0		+0.2 0		+0.2 0
t	Min. (mm)	0.7		0.8		0.9

# Installation Procedure

## Step 14 Optional: Extending the power cable

1 Prepare the following tools.

Tools	Spec	Shape
Crimping pliers	MH-14	
Connection sleeve (mm)	20 x Ø6.5 (H x OD)	
Insulation tape	Width 19 mm	
Contraction tube (mm)	70 x Ø8.0 (L x OD)	

2 As shown in the figure, peel off the shields from the rubber and wire of the power cable.

- Peel off 20 mm of cable shields from the pre-installed tube.

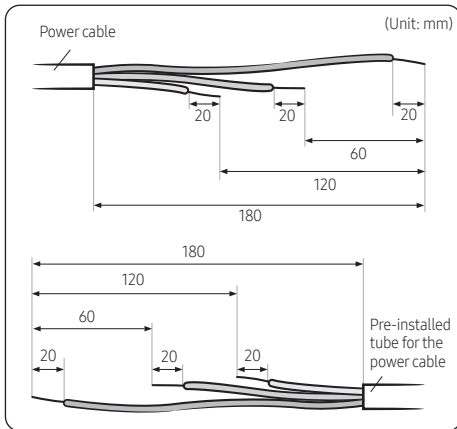

### CAUTION

- For information about the power cable specifications for indoor and outdoor units, refer to the installation manual.
- After peeling off cable wires from the pre-installed tube, insert a contraction tube.

3 Insert both sides of core wire of the power cable into the connection sleeve.

- **Method 1:** Push the core wire into the sleeve from both sides.
- **Method 2:** Twist the wire cores together and push it into the sleeve.

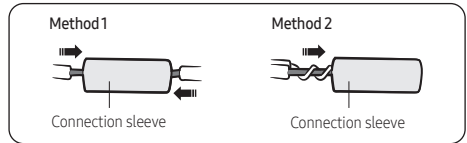

### CAUTION

- If cable wires are connected without using connecting sleeves, their contact area becomes reduced, or corrosion develops on the outer surfaces of the wires (copper wires) over a long time. This may cause an increase of resistance (reduction of passing current) and consequently may result in a fire.

4 Using a crimping tool, compress the two points and flip it over and compress another two points in the same location.

- The compression dimension should be 8.0.

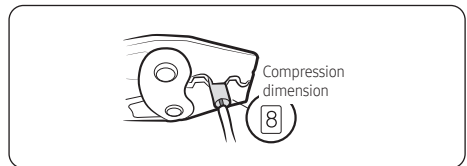

- After compressing it, pull both sides of the wire to make sure it is firmly pressed.

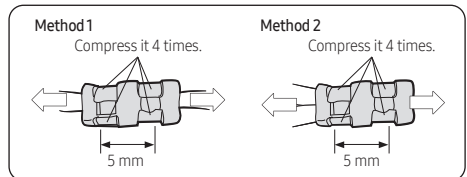

- 5 Apply heat to the contraction tube to contract it.

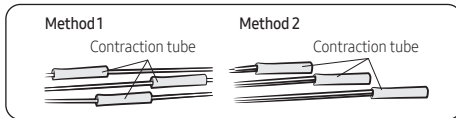

- 6 Wrap it with the insulation tape twice or more and position your contraction tube in the middle of the insulation tape.

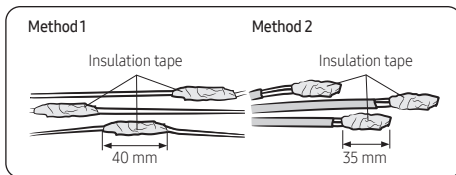

- 7 After tube contraction work is completed, wrap it with the insulation tape to finish. Three or more layers of insulation are required.

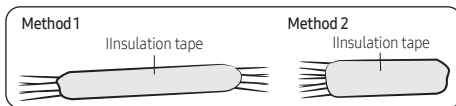

### CAUTION

- Make sure that the connection parts are not exposed to outside.
- Be sure to use insulation tape and a contraction tube made of approved reinforced insulating materials that have the same level of withstand voltage with the power cable. (Comply with the local regulations on extensions.)

### WARNING

- In case of extending the electric wire, please DO NOT use a round-shaped Pressing socket.
  - Incomplete wire connections can cause electric shock or a fire.

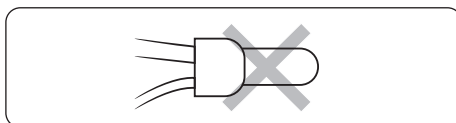

## Step 15 Setting the indoor unit addresses and the installation options

You cannot set both of the indoor unit addresses and the installation options in a batch: set both of them respectively.

## Common steps for setting the addresses and options

### AR-KH\*\*U remote control (for 360 cassette only)

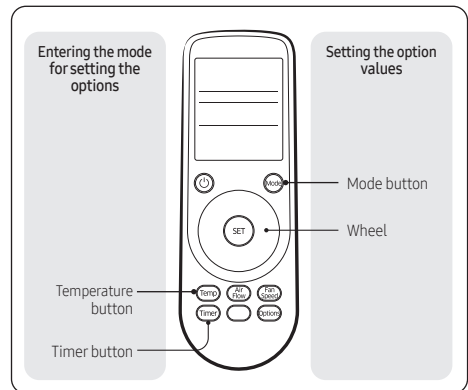

### NOTE

- The remote control display may vary depending on the model.

- 1 Enter the mode for setting the options:
  - a Remove the batteries from the remote control.
  - b While holding down the **Temp** (Temp) and **Timer** (Timer) buttons simultaneously, insert the batteries into the remote control.
  - c Make sure that you are entered to the mode for setting the options:

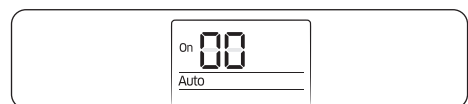

# Installation Procedure

2 Set the option values.

## CAUTION

- The total number of available options are 24: SEG1 to SEG24.
- Because SEG1, SEG7, SEG13, and SEG19 are the page options used by the previous remote control models, the modes to set values for these options are skipped automatically.
- Set a 2-digit value for each option pair in the following order: SEG2 and SEG3 → SEG4 and SEG5 → SEG6 and SEG8 → SEG9 and SEG10 → SEG11 and SEG12 → SEG14 and SEG15 → SEG16 and SEG17 → SEG18 and SEG20 → SEG21 and SEG22 → SEG23 and SEG24















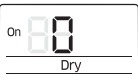









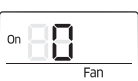





SEG1	SEG2	SEG3	SEG4	SEG5	SEG6
0	X	X	X	X	X
SEG7	SEG8	SEG9	SEG10	SEG11	SEG12
1	X	X	X	X	X
SEG13	SEG14	SEG15	SEG16	SEG17	SEG18
2	X	X	X	X	X
SEG19	SEG20	SEG21	SEG22	SEG23	SEG24
3	X	X	X	X	X

On (SEG1 to SEG12)	Off (SEG13 to SEG24)











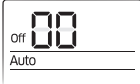

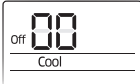

Take the steps presented in the following table:

Steps	Remote control display
<p><b>1</b> Set the SEG2 and SEG3 values:</p> <p><b>a</b> Set the SEG2 value by rotating the Wheel counterclockwise until the value you want to set appears on the remote control display.</p> <p><b>b</b> Set the SEG3 value by rotating the Wheel clockwise until the value you want to set appears on the remote control display.</p>	<p>SEG2</p> <p>SEG3</p>
When you rotate the Wheel, values appear in the following order: 0 → 1 → ... → E → F	
<p><b>2</b> Press the  (Mode) button. <b>Cool</b> and <b>On</b> appear on the remote control display.</p>	
<p><b>3</b> Set the SEG4 and SEG5 values:</p> <p><b>a</b> Set the SEG4 value by rotating the Wheel counterclockwise until the value you want to set appears on the remote control display.</p> <p><b>b</b> Set the SEG5 value by rotating the Wheel clockwise until the value you want to set appears on the remote control display.</p>	<p>SEG4</p> <p>SEG5</p>
When you rotate the Wheel, values appear in the following order: 0 → 1 → ... → E → F	

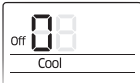

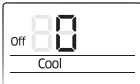



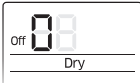
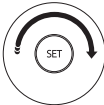
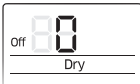



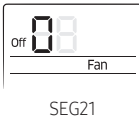

Steps	Remote control display
<b>4</b> Press the  (Mode) button. <b>Dry</b> and <b>On</b> appear on the remote control display.	
<b>5</b> Set the SEG6 and SEG8 values: <ul style="list-style-type: none"> <li data-bbox="127 418 631 466"><b>a</b> Set the SEG6 value by rotating the Wheel counterclockwise until the value you want to set appears on the remote control display.</li> <li data-bbox="127 513 645 561"><b>b</b> Set the SEG8 value by rotating the Wheel clockwise until the value you want to set appears on the remote control display.</li> </ul>	<div style="display: flex; flex-direction: column; align-items: center;">   <p style="text-align: center;">SEG6</p>   <p style="text-align: center;">SEG8</p> </div>
When you rotate the Wheel, values appear in the following order:  •     • ... •  • 	
<b>6</b> Press the  (Mode) button. <b>Fan</b> and <b>On</b> appear on the remote control display.	
<b>7</b> Set the SEG9 and SEG10 values: <ul style="list-style-type: none"> <li data-bbox="127 807 631 855"><b>a</b> Set the SEG9 value by rotating the Wheel counterclockwise until the value you want to set appears on the remote control display.</li> <li data-bbox="127 903 654 951"><b>b</b> Set the SEG10 value by rotating the Wheel clockwise until the value you want to set appears on the remote control display.</li> </ul>	<div style="display: flex; flex-direction: column; align-items: center;">   <p style="text-align: center;">SEG9</p>   <p style="text-align: center;">SEG10</p> </div>
When you rotate the Wheel, values appear in the following order:  •     • ... •  • 	
<b>8</b> Press the  (Mode) button. <b>Heat</b> and <b>On</b> appear on the remote control display.	
<b>9</b> Set the SEG11 and SEG12 values: <ul style="list-style-type: none"> <li data-bbox="127 1241 631 1289"><b>a</b> Set the SEG11 value by rotating the Wheel counterclockwise until the value you want to set appears on the remote control display.</li> <li data-bbox="127 1337 654 1385"><b>b</b> Set the SEG12 value by rotating the Wheel clockwise until the value you want to set appears on the remote control display.</li> </ul>	<div style="display: flex; flex-direction: column; align-items: center;">   <p style="text-align: center;">SEG11</p>   <p style="text-align: center;">SEG12</p> </div>
When you rotate the Wheel, values appear in the following order:  •     • ... •  • 	

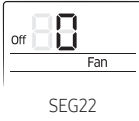
# Installation Procedure

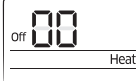
Steps	Remote control display
<b>10</b> Press the  (Mode) button. <b>Auto</b> and <b>Off</b> appear on the remote control display.	
<b>11</b> Set the SEG14 and SEG15 values: <ul style="list-style-type: none"> <li data-bbox="135 416 644 464"><b>a</b> Set the SEG14 value by rotating the Wheel counterclockwise until the value you want to set appears on the remote control display.</li> <li data-bbox="135 517 658 564"><b>b</b> Set the SEG15 value by rotating the Wheel clockwise until the value you want to set appears on the remote control display.</li> </ul>	  <p style="text-align: center;">SEG14</p>   <p style="text-align: center;">SEG15</p>
When you rotate the Wheel, values appear in the following order: <b>0 - 1 - ... - E - F</b>	
<b>12</b> Press the  (Mode) button. <b>Cool</b> and <b>Off</b> appear on the remote control display.	
<b>13</b> Set the SEG16 and SEG17 values: <ul style="list-style-type: none"> <li data-bbox="135 815 644 863"><b>a</b> Set the SEG16 value by rotating the Wheel counterclockwise until the value you want to set appears on the remote control display.</li> <li data-bbox="135 916 658 963"><b>b</b> Set the SEG17 value by rotating the Wheel clockwise until the value you want to set appears on the remote control display.</li> </ul>	  <p style="text-align: center;">SEG16</p>   <p style="text-align: center;">SEG17</p>
When you rotate the Wheel, values appear in the following order: <b>0 - 1 - ... - E - F</b>	
<b>14</b> Press the  (Mode) button. <b>Dry</b> and <b>Off</b> appear on the remote control display.	
<b>15</b> Set the SEG18 and SEG20 values: <ul style="list-style-type: none"> <li data-bbox="135 1214 644 1262"><b>a</b> Set the SEG18 value by rotating the Wheel counterclockwise until the value you want to set appears on the remote control display.</li> <li data-bbox="135 1315 658 1362"><b>b</b> Set the SEG20 value by rotating the Wheel clockwise until the value you want to set appears on the remote control display.</li> </ul>	  <p style="text-align: center;">SEG18</p>   <p style="text-align: center;">SEG20</p>
When you rotate the Wheel, values appear in the following order: <b>0 - 1 - ... - E - F</b>	

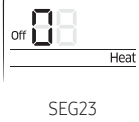
Installation Procedure

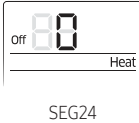
Steps	Remote control display
<b>16</b> Press the  (Mode) button. <b>Fan</b> and <b>Off</b> appear on the remote control display.	
<b>17</b> Set the SEG21 and SEG22 values: <ul style="list-style-type: none"> <li data-bbox="128 418 636 466"><b>a</b> Set the SEG21 value by rotating the Wheel counterclockwise until the value you want to set appears on the remote control display.</li> <li data-bbox="128 518 651 566"><b>b</b> Set the SEG22 value by rotating the Wheel clockwise until the value you want to set appears on the remote control display.</li> </ul>	   
When you rotate the Wheel, values appear in the following order: <b>0</b> • <b>1</b> • <b>...</b> • <b>E</b> • <b>F</b>	
<b>18</b> Press the  (Mode) button. <b>Heat</b> and <b>Off</b> appear on the remote control display.	
<b>19</b> Set the SEG23 and SEG24 values: <ul style="list-style-type: none"> <li data-bbox="128 812 636 860"><b>a</b> Set the SEG23 value by rotating the Wheel counterclockwise until the value you want to set appears on the remote control display.</li> <li data-bbox="128 912 651 960"><b>b</b> Set the SEG24 value by rotating the Wheel clockwise until the value you want to set appears on the remote control display.</li> </ul>	   
When you rotate the Wheel, values appear in the following order: <b>0</b> • <b>1</b> • <b>...</b> • <b>E</b> • <b>F</b>	

# Installation Procedure

3 Check whether the option values that you have set are correct by pressing the **Mode** button repeatedly.

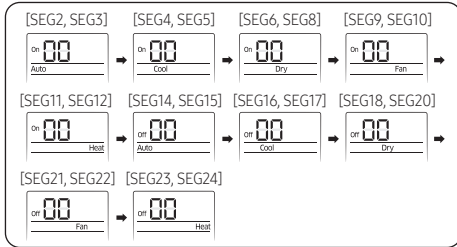

4 Save the option values into the indoor unit: Point the remote control to the remote control sensor on the indoor unit and then press the **Power** button on the remote control twice. Make sure that this command is received by the indoor unit. When it is successfully received, you can hear a short sound from the indoor unit. If the command is not received, press the **Power** button again.

5 Check whether the air conditioner operates in accordance with the option values you have set:

- Reset the indoor unit by disconnecting and then reconnecting the power cable of the indoor unit or by pressing the RESET button on the outdoor unit.
- Remove the batteries from the remote control, insert them again, and then press the **Power** button on the remote control.

## NOTE

- The remote control display and buttons may vary depending on the model.
- Enter the mode for setting the options:
    - Remove the batteries from the remote control, and then insert them again.
    - While holding down the **High Temp** and **Low Temp** buttons simultaneously, insert the batteries into the remote control.
    - Make sure that you are entered to the mode for setting the options:

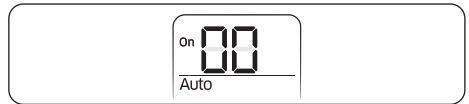

2 Set the option values.

## CAUTION

- The total number of available options are 24: SEG1 to SEG24.
- Because SEG1, SEG7, SEG13, and SEG19 are the page options used by the previous remote control models, the modes to set values for these options are skipped automatically.
- Set a 2-digit value for each option pair in the following order: SEG2 and SEG3 → SEG4 and SEG5 → SEG6 and SEG8 → SEG9 and SEG10 → SEG11 and SEG12 → SEG14 and SEG15 → SEG16 and SEG17 → SEG18 and SEG20 → SEG21 and SEG22 → SEG23 and SEG24



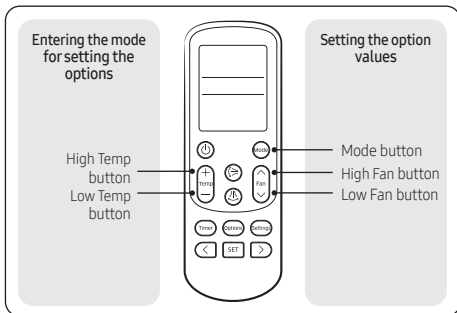











## MR-EH00U and AR-EH\*\*U remote controls



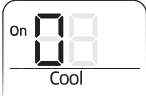
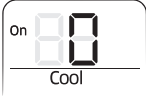













SEG1	SEG2	SEG3	SEG4	SEG5	SEG6
0	X	X	X	X	X
SEG7	SEG8	SEG9	SEG10	SEG11	SEG12
1	X	X	X	X	X
SEG13	SEG14	SEG15	SEG16	SEG17	SEG18
2	X	X	X	X	X
SEG19	SEG20	SEG21	SEG22	SEG23	SEG24
3	X	X	X	X	X





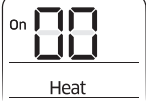

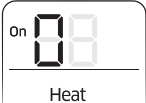
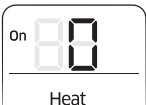









On (SEG1 to SEG12)	Off (SEG13 to SEG24)
On 00 Auto	Off 00 Auto

Take the steps presented in the following table:

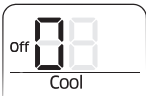
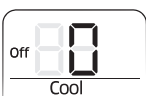





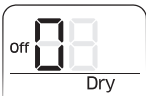



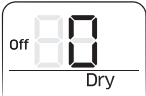





Steps	Remote control display
<p><b>1</b> Set the SEG2 and SEG3 values:</p> <p><b>a</b> Set the SEG2 value by pressing the  (Low Fan) button repeatedly until the value you want to set appears on the remote control display.</p> <p><b>b</b> Set the SEG3 value by rotating the Wheel clockwise until the value you want to set appears on the remote control display.</p>	 <p style="text-align: center;">SEG2</p>  <p style="text-align: center;">SEG3</p>
<p>When you press the  (Low Fan) or  (High Fan) button, values appear in the following order: <math>\square \rightarrow \square \rightarrow \square \rightarrow \square \rightarrow \square \rightarrow \square</math></p>	
<p><b>2</b> Press the  (Mode) button. <b>Cool</b> and <b>On</b> appear on the remote control display.</p>	
<p><b>3</b> Set the SEG4 and SEG5 values:</p> <p><b>a</b> Set the SEG4 value by pressing the  (Low Fan) button repeatedly until the value you want to set appears on the remote control display.</p> <p><b>b</b> Set the SEG5 value by rotating the Wheel clockwise until the value you want to set appears on the remote control display.</p>	 <p style="text-align: center;">SEG4</p>  <p style="text-align: center;">SEG5</p>
<p>When you press the  (Low Fan) or  (High Fan) button, values appear in the following order: <math>\square \rightarrow \square \rightarrow \square \rightarrow \square \rightarrow \square \rightarrow \square</math></p>	
<p><b>4</b> Press the  (Mode) button. <b>Dry</b> and <b>On</b> appear on the remote control display.</p>	
<p><b>5</b> Set the SEG6 and SEG8 values:</p> <p><b>a</b> Set the SEG6 value by pressing the  (Low Fan) button repeatedly until the value you want to set appears on the remote control display.</p>	 <p style="text-align: center;">SEG6</p>

# Installation Procedure

Steps	Remote control display
<p><b>b</b> Set the SEG8 value by rotating the Wheel clockwise until the value you want to set appears on the remote control display.</p>	 <p style="text-align: center;">SEG8</p>
<p>When you press the  (Low Fan) or  (High Fan) button, values appear in the following order: <b>Q - I - ... E - F</b></p>	
<p><b>6</b> Press the  (Mode) button. <b>Fan</b> and <b>On</b> appear on the remote control display.</p>	
<p><b>7</b> Set the SEG9 and SEG10 values:</p> <p><b>a</b> Set the SEG9 value by pressing the  (Low Fan) button repeatedly until the value you want to set appears on the remote control display.</p> <p><b>b</b> Set the SEG10 value by rotating the Wheel clockwise until the value you want to set appears on the remote control display.</p>	 <p style="text-align: center;">SEG9</p>  <p style="text-align: center;">SEG10</p>
<p>When you press the  (Low Fan) or  (High Fan) button, values appear in the following order: <b>Q - I - ... E - F</b></p>	
<p><b>8</b> Press the  (Mode) button. <b>Heat</b> and <b>On</b> appear on the remote control display.</p>	
<p><b>9</b> Set the SEG11 and SEG12 values:</p> <p><b>a</b> Set the SEG11 value by pressing the  (Low Fan) button repeatedly until the value you want to set appears on the remote control display.</p> <p><b>b</b> Set the SEG12 value by rotating the Wheel clockwise until the value you want to set appears on the remote control display.</p>	 <p style="text-align: center;">SEG11</p>  <p style="text-align: center;">SEG12</p>
<p>When you press the  (Low Fan) or  (High Fan) button, values appear in the following order: <b>Q - I - ... E - F</b></p>	

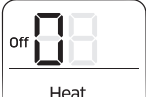
Steps	Remote control display
<b>10</b> Press the  (Mode) button. <b>Auto</b> and <b>Off</b> appear on the remote control display.	
<b>11</b> Set the SEG14 and SEG15 values: <ol style="list-style-type: none"> <li>Set the SEG14 value by pressing the  (Low Fan) button repeatedly until the value you want to set appears on the remote control display.</li> <li>Set the SEG15 value by rotating the Wheel clockwise until the value you want to set appears on the remote control display.</li> </ol>	 <p style="text-align: center;">SEG14</p>  <p style="text-align: center;">SEG15</p>
When you press the  (Low Fan) or  (High Fan) button, values appear in the following order: 0 → 1 → ... → E → F	
<b>12</b> Press the  (Mode) button. <b>Cool</b> and <b>Off</b> appear on the remote control display.	
<b>13</b> Set the SEG16 and SEG17 values: <ol style="list-style-type: none"> <li>Set the SEG16 value by pressing the  (Low Fan) button repeatedly until the value you want to set appears on the remote control display.</li> <li>Set the SEG17 value by rotating the Wheel clockwise until the value you want to set appears on the remote control display.</li> </ol>	 <p style="text-align: center;">SEG16</p>  <p style="text-align: center;">SEG17</p>
When you press the  (Low Fan) or  (High Fan) button, values appear in the following order: 0 → 1 → ... → E → F	
<b>14</b> Press the  (Mode) button. <b>Dry</b> and <b>Off</b> appear on the remote control display.	
<b>15</b> Set the SEG18 and SEG20 values: <ol style="list-style-type: none"> <li>Set the SEG18 value by pressing the  (Low Fan) button repeatedly until the value you want to set appears on the remote control display.</li> </ol>	 <p style="text-align: center;">SEG18</p>



# Installation Procedure

Steps	Remote control display
<p><b>b</b> Set the SEG20 value by rotating the Wheel clockwise until the value you want to set appears on the remote control display.</p>	 <p style="text-align: center;">SEG20</p>
<p>When you press the  (Low Fan) or  (High Fan) button, values appear in the following order: <b>0</b> → <b>1</b> → ... <b>E</b> → <b>F</b></p>	
<p><b>16</b> Press the  (Mode) button. <b>Fan</b> and <b>Off</b> appear on the remote control display.</p>	
<p><b>17</b> Set the SEG21 and SEG22 values:</p> <p><b>a</b> Set the SEG21 value by pressing the  (Low Fan) button repeatedly until the value you want to set appears on the remote control display.</p> <p><b>b</b> Set the SEG22 value by rotating the Wheel clockwise until the value you want to set appears on the remote control display.</p>	 <p style="text-align: center;">SEG21</p>  <p style="text-align: center;">SEG22</p>
<p>When you press the  (Low Fan) or  (High Fan) button, values appear in the following order: <b>0</b> → <b>1</b> → ... <b>E</b> → <b>F</b></p>	
<p><b>18</b> Press the  (Mode) button. <b>Fan</b> and <b>Off</b> appear on the remote control display.</p>	
<p><b>19</b> Set the SEG23 and SEG24 values:</p> <p><b>a</b> Set the SEG23 value by pressing the  (Low Fan) button repeatedly until the value you want to set appears on the remote control display.</p> <p><b>b</b> Set the SEG24 value by rotating the Wheel clockwise until the value you want to set appears on the remote control display.</p>	 <p style="text-align: center;">SEG23</p>  <p style="text-align: center;">SEG24</p>
<p>When you press the  (Low Fan) or  (High Fan) button, values appear in the following order: <b>0</b> → <b>1</b> → ... <b>E</b> → <b>F</b></p>	

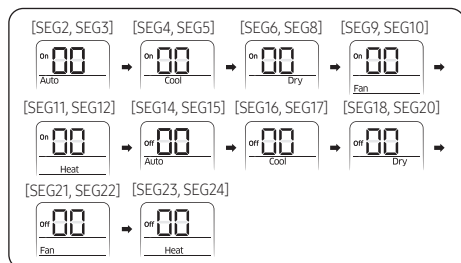

- 3 Check whether the option values that you have set are correct by pressing the  (Mode) button repeatedly.



- 4 Save the option values into the indoor unit:  
Point the remote control to the remote control sensor on the indoor unit and then press the  (Power) button on the remote control twice. Make sure that this command is received by the indoor unit. When it is successfully received, you can hear a short sound from the indoor unit. If the command is not received, press the  (Power) button again.
- 5 Check whether the air conditioner operates in accordance with the option values you have set:
- Reset the indoor unit by disconnecting and then reconnecting the power cable of the indoor unit or by pressing the RESET button on the outdoor unit.
  - Remove the batteries from the remote control, insert them again, and then press the  (Power) button on the remote control.

## Setting the indoor unit addresses

**Option No. for an indoor unit address:**  
0AXXXX-1XXXX-2XXXX-3XXXX

Before installing an indoor unit, be sure to set an address for the indoor unit by taking the following steps:

- 1 Make sure that the power is supplied to the indoor unit. If the indoor unit is not plugged in, it must include a power supply.

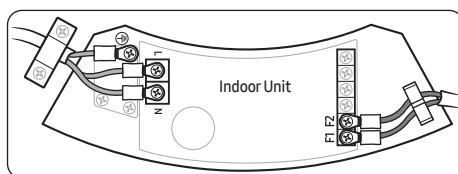

- 2 Make sure that the panel is connected to the indoor unit so that it can receive options.
- 3 Set an address for each indoor unit using the remote control, according to your air conditioning system plan, by referring to the following table and by following the steps in Common steps for setting the addresses and options on page 23.
  - The indoor unit addresses (main and RMC addresses) are set to 0A0000-100000-200000-300000 by default.
  - If indoor units and outdoor units match 1:1, you don't need to set the addresses.
  - The main address of each indoor unit is set automatically. However, you can set the main address manually if the relevant outdoor option is set to MANUAL ADDRESS.

# Installation Procedure

Option	SEG1		SEG2		SEG3		SEG4	SEG5		SEG6	
Function	Page		Mode		Setting main address		Reserved	Indoor unit number		Indoor unit number	
Indication and details	Indication	Details	Indication	Details	Indication	Details		Indication	Details	Indication	Details
	0	0		A		0		No main address	0 to 1	Tens digit	0 to 9
					1	Main address setting mode					

Option	SEG7		SEG8		SEG9		SEG10	SEG11		SEG12	
Function	Page		Reserved		Setting RMC address		Reserved	Group channel (x16)		Group address	
Indication and details	Indication	Details			Indication	Details		Indication	Details	Indication	Details
	1					0		No RMC address	RMC1	0 to 2	RMC2
					1	RMC address setting mode					

## ⚠ CAUTION

- The main address must be set to a value in the range 0 to 14. If you set other values, communication error will occur.
- If any of SEG5 and SEG6 is set to a value in the range A to F, the main address of the indoor unit does not change.
- If SEG3 is set to 0, the indoor unit maintains the existing main address even if SEG6 is set to a new value.
- If SEG9 is set 0, the indoor unit maintains the existing RMC address even if SEG11 and SET12 are set to new values.

### Setting the installation options in a batch

Option No. for an indoor unit address:  
02XXXX-1XXXXX-2XXXXX-3XXXXX

- 1 Make sure that the power is supplied to the indoor unit. If the indoor unit is not plugged in, it must include a power supply.

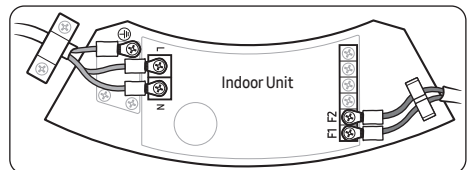

- 2 Make sure that the panel is connected to the indoor unit so that it can receive options
- 3 Set the installation options of indoor units, by referring to the following table and by following the steps in **Common steps for setting the addresses and options** on page 23.

- The installation options of indoor units are set to 020010-100000-200000-300000 by default.
- The SEG20 option, Individual control with remote control, allows you to control multiple indoor units individually by using the remote control.

Option	SEG1		SEG2		SEG3	SEG4			SEG5		SEG6	
Function	Page		Mode		Reserved	Use of external room temperature sensor / Minimizing fan operation when thermostat is off <sup>3)</sup>			Central control		Compensation of the fan RPM	
Indication and details	Indication	Details	Indication	Details		Indication	Details		Indication	Details	Indication	Details
	0	2	Use of external room temperature sensor	Minimizing fan operation when thermostat is off			0	Disuse				
1			Use	Disuse	1	High-ceiling mode (Recessed installation)						
2			Disuse	Use (Heating)	4	Disuse (Exposed installation)						
3			Use	Use (Heating)	5	High-ceiling mode (Exposed installation)						
4			Disuse	Use (Cooling)								
5			Use	Use (Cooling)								
6			Disuse	Use (Cooling/Heating)								
7			Use	Use (Cooling/Heating)								
8			Disuse	Use (Cooling Ultra low speed)	1	Use						
9			Use	Use (Cooling Ultra low speed)								
A			Disuse	Use (Heating/Cooling Ultra low speed)								
B	Use	Use (Heating/Cooling Ultra low speed)										
Option		SEG7	SEG8				SEG9	SEG10	SEG11	SEG12		
Function	Page		Use of drain pump 2)				Reserved	Reserved	Reserved	Reserved		
Indication and details	1	0	Disuse									
		1	Use									
		2	Use with 3 minute delay									
Option	SEG13	SEG14		SEG15	SEG16	SEG17	SEG18					
Function	Page		Use of external control <sup>3)</sup>		Setting the output of external control		Reserved	Buzzer control		Maximum filter usage time <sup>4)</sup>		
Indication and details	2	0	Disuse		0	Thermo on		0	Use of buzzer	2	1000 hours	
		1	On/Off									Sub, Existing control
		2	Off									
		3	Window On/Off									
		4	Disuse									Main, Existing control
		5	On/Off									
		6	Off									
		7	Window On/Off		1	Operation On		1	Disuse of buzzer	6	2000 hours	
		8	Disuse									Sub, Reverse control
		9	On/Off									
		A	Off									
		B	Window On/Off									Main, Reverse control
		C	Disuse									
D	On/Off											
E	Off											
F	Window On/Off											

# Installation Procedure

Option	SEG19		SEG20		SEG21		SEG22	SEG23				SEG24					
Function	Page		Individual control with remote control <sup>5)</sup>		Heating setting compensation <sup>4)</sup>		Reserved	Setting the MDS Kit installation option <sup>7)</sup>				Cycle time of swing					
Indication and details	Indication	Details	Indication	Details	Indication	Details		Indication		Details		Indication	Details				
	3	0,1	Indoor1	0	Default	0		2°C	0		Disuse (Soft Off+Hard off)		0	34 seconds (default)			
							Standard		1		Off after 20 min. (Soft Off+Hard off)						
									2		Off after 40 min. (Soft Off+Hard off)						
									3		Off after 80 min. (Soft Off+Hard off)						
		2		Indoor2			1		2°C	Premium		4		Off after 20 min. (Soft Off+Hard off)			
				3						Indoor3		5		Off after 40 min. (Soft Off+Hard off)			
				4			Indoor4		2		5°C		6		Off after 80 min. (Soft Off+Hard off)		
									Standard		7		Off after 20 min. (Soft Off only)				
											8		Off after 40 min. (Soft Off only)				
									9		Off after 80 min. (Soft Off only)						
						Premium		A		Off after 20 min. (Soft Off only)							
								B		Off after 40 min. (Soft Off only)							
								C		Off after 80 min. (Soft Off only)							
										2		38 seconds					

- 1) SEG4  
By SEG4 setting, Minimizing fan operation when thermostat is off.
  - Fan operates for 20 seconds at an interval of 5 minutes in heat mode.
  - Fan stops or operates Ultra low in Cooling when thermostat is off.
- 2) SEG8  
Even if you set the Use of drain pump option to 0, it is automatically set to 2 (the drain pump is used with 3 minute delay).
- 3) SEG14  
Example: When installing DPM (1 Outdoor unit with 4 indoor units)

Condition		SEG14 Setting				Result
External control	Level control	Indoor1	Indoor2	Indoor3	Indoor4	
Default		Not set (0)				Slave (All)
Disuse	Use	4	Not set (0)	Not set (0)	Not set (0)	Master (Indoor 1), Slave (Indoor 2,3,4)
Use (Indoor 3)	Disuse	Not set (0)	Not set (0)	1-3	Not set (0)	Slave (All)
Use (Indoor 4)	Use	Not set (0)	Not set (0)	Not set (0)	5-7	Master (Indoor 4), Slave (Indoor 1,2,3)

- 4) SEG18  
If you set the Maximum filter usage time option to a value other than 2 and 6, it is automatically set to 2 (1000 hours).
- 5) SEG20  
If you set the Individual control with remote control option to a value other than 0 to 4, it is automatically set to 0 (Indoor 1)
- 6) SEG21  
Default value of Heating setting compensation is 5°C.
- 7) SEG23  
**Soft Off:** The indoor unit turns off its operation at the indicated time in the table for Installation Option after its final motion detection. But, it turns on again if the MDS detects motion.  
**Hard Off:** Designated time after SOFT OFF, it cannot turn on automatically when it detects motion. Users should control to turn on the indoor unit with remote control, etc.

## Changing the addresses and options individually

When you want to change the value of a specific option, refer to the following table and follow the steps in **Common steps for setting the addresses and options** on page 23.

Option	SEG1		SEG2		SEG3		SEG4		SEG5		SEG6	
Function	Page		Mode		Type of the option to change		Tens position of the option number		Units position of the option number		New value	
Indication and details	Indication	Details	Indication	Details	Indication	Details	Indication	Details	Indication	Details	Indication	Details
	0		D		Option type	0 to F	Tens position value	0 to 9	Units position value	0 to 9	New value	0 to F

Example: Changing the Buzzer control (SEG17) option of the installation options to 1 disuse.

Option	SEG1	SEG2	SEG3	SEG4	SEG5	SEG6
Function	Page	Mode	Type of the option to change	Tens position of the option number	Units position of the option number	New value
Indication	0	D	2	1	7	1

## Step 16. Optional: Installing DPM (Digital Packaged Multi)

### NOTE

Only AC052/071BN6PKG models are available to install DPM.

To find DPM allowable indoor unit models according to outdoor unit models, refer to outdoor installation manual.

- When installing DPM, you should set "DPM setting" to the outdoor unit.
- You do not need to set the address manually for the indoor unit.
- If DPM model is not set, communication error may occur.
- While the outdoor unit is tracking the indoor unit for one minute after the power supply is turned on, the operation may stop if the remote control reception signal of the installed indoor unit is different.
- To enable Level control with the centralized controller, refer to page 35 ~ 36.

### CAUTION

- When installing DPM, only one external controller can be connected.

# Installation Procedure

## Step 17. Optional : Setting the Emergency Temperature Output (ETO) function

### ⚠ CAUTION

- In order to deploy the ETO function, the MIM-B14, an external contact interface module, must be installed in each indoor unit.
  - The ETO is a concept of emergency operation of indoor units. If the indoor unit 1 (main indoor unit) stops because of an error, the indoor unit 2 (sub indoor unit) starts to operate.
  - Basically, the indoor unit 2 operates in the previous mode. [For the first time operation, it starts in 24 °C Auto mode.]
  - To set more detailed operation conditions for the indoor unit 2, use the S-net Pro.

### Emergency Temperature Output (ETO) function

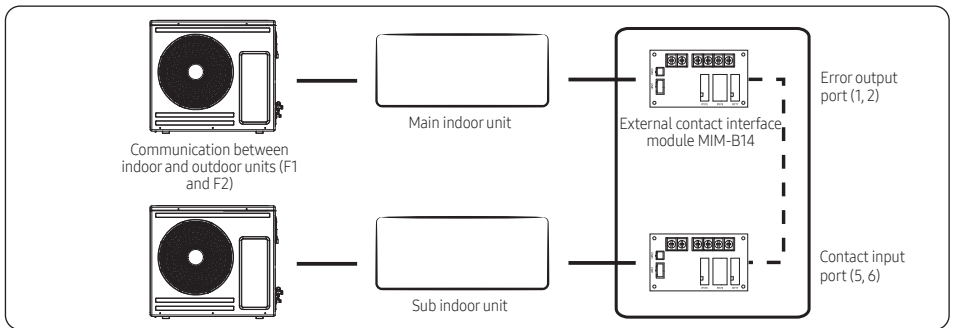

- 1 Main indoor unit
  - Disable the external contact control (Default).
  - Connect the S-net pro2 to F1 and F2.
  - Enable the ETO function and set the temperature and time.
- 2 Sub indoor unit
  - (Required) Enable the external contact control (with the installation option SEG14 - Reverse Control).
  - Connect the S-net pro2 to F1 and F2.
  - Enable the entrance control and set the mode, set temperature, and fan speed.

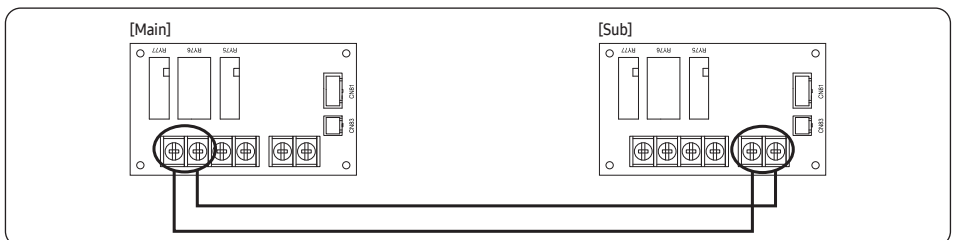

## ETO operation specifications

### 1 Main indoor unit

- Based on the external contact control settings, the main indoor unit decides whether to generate output when an error (indoor unit stop) occurs.
- Based on the ETO settings, the main indoor unit decides whether to generate output according to the temperature and time conditions.

### 2 Sub indoor unit

- Based on the entrance control settings, the sub indoor unit decides the mode, set temperature, and fan speed when contact inputs are given.

	Enable of ETO	Enable of external contact	Error port output
Main indoor unit	X	X	N/A
	X	O	Output due to an error
	O	X	Output by ETO entrance conditions (temperature / time / error occurrence)
	O	O	Output by ETO entrance conditions (temperature / time / error occurrence) ※ Ready to control the main contact input

	Enable of entrance control	Enable of external contact	Operation when outputting Main
Sub indoor unit	X	X	N/A
	X	O	On with the previous operation conditions
	O	O	On with the entrance control enabled

# Installation Procedure

## Step 18. Optional : LED Display indicator specifications when checking Wi-Fi Easy Setup and Wi-Fi status (This feature can be used when installing single Wi-Fi kit)

The AR-KH04U wireless remote controller can be used for Easy Setup, checking internet connection status and connecting or disconnecting Wi-Fi. (This feature can be used when installing single Wi-Fi kit)

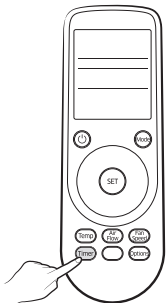
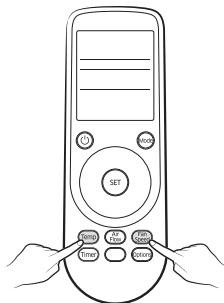
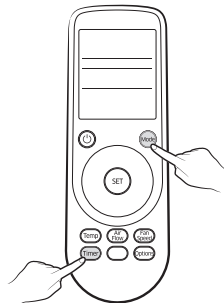
Easy Setup	Check internet connection status	Connect / Disconnect to Wi-Fi
		
Press the [Timer] button for 5 seconds	Press the [Temp] and [Fan Speed] button simultaneously for 5 seconds	Press the [Mode] and [Timer] button simultaneously for 5 seconds

### LED Indicator Status

360 Cassette		LED Display							Remarks	Measure
		LED colour of indicator lights				LED indicator for wind direction				
		Ice blue	blue	Yellow green	Red	Wide	Mid	Spot		
Easy Setup	AP entry	●	X	X	X	●	●	●	All LED lights are on	-
	Check device	●	X	X	X	●	●	●	All LED lights flash	-
	Registering devices	X	X	X	X	●	●	●	LED lights for wind direction flashes in order	-
	Connected	●	X	X	X	●	●	●	All LED lights flash for 3 seconds	-
	Connection failed	X	X	X	●	X	X	X	Red LED indicator lights turns on, all LED lights for wind direction turns off	Retry AP settings, change Wi-Fi module
Check internet connection status	If AP/internet is connected successfully	●	X	X	X	●	●	●	All LED lights turns on for 5 seconds	Normal operation
	If no AP connection	X	X	X	X	X	X	X	All LED turns off for 5 seconds	AP settings, change Wi-Fi module
Wi-Fi	If connected	●	X	X	X	●	●	●	All LED lights flashes once	-
	If not connected	●	X	X	X	●	●	●	All LED lights flashes once	-
If AP is set up using the wired remote controller		●	X	X	X	●	●	●	All LED lights flashes simultaneously (max. 5 mins)	-



# Troubleshooting

Condition	Indoor unit display indications			
	Ice blue	Yellow green	Blue	Red
Power reset (blinking once every 2 seconds)	●	X	X	X
In the defrost operation (blinking once every 10 seconds)	●	X	X	X
Open or short circuit error of the indoor-temperature sensor	X	X	X	●
Error of the outdoor unit	X	X	●	X
Communication error between the indoor and outdoor units	X	●	X	X
Open or short circuit error of a sensor (evaporator-in, evaporator-out, or discharge sensor) in the indoor unit	X	●	X	●
Error of the fan in the indoor unit	X	X	●	●
Error of the second detection of the float switch	X	●	●	X
Open circuit error of the thermal fuse	●	X	●	X
EEPROM error	●	●	X	●
MDS (Motion Detecting Sensor) Error	●	●	●	X

● : On, ● : Blinking, X : Off



This appliance is filled with R-32.